

User's Manual

PCR-T2300

PCR-T2400

SE-S3000

Electronic Cash Register



(M size drawer)

Introduction

Thank you very much for purchasing this CASIO electronic cash register. START-UP is QUICK and EASY!

For the basic settings of your cash register, please see “Quick Start Guide”.

IMPORTANT

For programming assistance please visit
http://casio4business.com/sa_index.html

CASIO Authorized Service Centers

If your CASIO product needs repair, or you wish to purchase replacement parts, please visit <http://casio-4business.com>.

Original Carton/Package

If for any reason, this product is to be returned to the store where purchased, it must be packed in the original carton/package.

Location

Locate the Cash register on a flat, stable surface, away from heaters or areas exposed to direct sunlight, humidity or dust.

Power Supply

Your cash register is designed to operate on standard household current (120 V, 50/60 Hz). Do not overload the outlet by plugging in too many appliances.

Cleaning

Clean the cash register exterior with a soft cloth which has been moistened with a solution of a mild neutral detergent and water, and wrung out. Be sure that the cloth is thoroughly wrung out to avoid damage to the printer. Never use paint thinner, benzene, or other volatile solvents.

The mains plug on this equipment must be used to disconnect mains power. Please ensure that the socket outlet is installed near the equipment and shall be easily accessible.

Trademark





SD and SDHC Logos are trademarks of SD-3C,LLC.





To use the cash register safely	E-4
To use the cash register's basic function	E-9
Getting started.....	E-10
Getting to know your cash register	E-14
How to read the printouts	E-19
How to use your cash register	E-20
Before opening your store.....	E-21
Registering items in departments	E-22
Basic setups and registrations	E-26
Other registrations	E-36
Daily sales reports	E-47
Advanced programmings and registrations	E-50
Advanced registrations.....	E-51
Character settings.....	E-55
Advanced programmings	E-64
Programming functions of departments and PLUs in a lump.....	E-73
Programming functions of departments and PLUs individually.....	E-76
Printing programmed data.....	E-84
Printing various sales reports.....	E-89
Using an SD card.....	E-96
Before you consider it as a problem	E-99
Specifications	E-103

To use the cash register safely

- Congratulations upon your selection of this CASIO product. Be sure to read the following safety precautions before using it for the first time. After reading this guide, keep it close at hand for easy reference.
- Please pay due attention to the following symbols to help you use the product safely and properly and to avoid any personal injury or damage to the product.

 Danger	If this symbol is ignored and the product consequently misused, it can result in serious personal injury and/or death.
 Warning	If this symbol is ignored and the product consequently misused, it may result in serious personal injury and/or death.
 Caution	If this symbol is ignored and the product consequently misused, it may result in personal injury and/or property damage.

- The figures in this manual have the following meanings.

	This symbol means be careful = a warning. The example at left is a warning about an electrical shock.
	This symbol indicates something you must not do = prohibited action. The example at left means never disassemble the product.
	This symbol indicates something you must do = an instruction. The example at left indicates you should unplug the product from the outlet. Please note that instructions that are difficult to express by a figure are indicated by  .

Danger

If liquid that leaked from a battery gets in your eye, on your skin or clothes, deal with it immediately as follows.



1. Immediately rinse it off with lots of water.
 2. Immediately get medical treatment.
- Failing to act may result in a rash or loss of sight.

Warning

Handling the register



- Should the register malfunction, start to emit smoke or a strange odor, or otherwise behave abnormally, immediately shut down the power and unplug the AC plug from the power outlet. Continued use creates the danger of fire and electric shock. Contact CASIO service representative.



- Do not place containers of liquids near the register and do not allow any foreign matter to get into it. Should water or other foreign matter get into the register, immediately shut down the power and unplug the AC plug from the power outlet. Continued use creates the danger of short circuit, fire and electric shock. Contact CASIO service representative.



- Should you drop the register and damage it, immediately shut down the power and unplug the AC plug from the power outlet. Continued use creates the danger of short circuit, fire and electric shock.







- Attempting to repair the register yourself is extremely dangerous. Contact CASIO service representative.
- Never try to take the register apart or modify it in any way. High-voltage components inside the register create the danger of fire and electric shock. Contact CASIO service representative for all repair and maintenance.

To use the cash register safely

Warning

Power plug and AC outlet

-  • Use only a proper AC electric outlet. Use of an outlet with a different voltage from the rating creates the danger of malfunction, fire, and electric shock. Overloading an electric outlet creates the danger of overheating and fire.
-  • Make sure the power plug is inserted as far as it will go. Loose plugs create the danger of electric shock, overheating, and fire.
- Do not use the register if the plug is damaged. Never connect to a power outlet that is loose.
-  • Use a dry cloth to periodically wipe off any dust built up on the prongs of the plug. Humidity can cause poor insulation and create the danger of electric shock and fire if dust stays on the prongs.
-  • Do not allow the power cord or plug to become damaged, and never try to modify them in any way. Continued use of a damaged power cord can cause deterioration of the insulation, exposure of internal wiring, and short circuit, which creates the danger of electric shock and fire.
- Contact CASIO service representative whenever the power cord or plug requires repair or maintenance.

Caution

-  • Do not place the register on an unstable or uneven surface. Doing so can cause the register - especially when the drawer is open - to fall, creating the danger of malfunction, fire, and electric shock.

Do not place the register in the following areas.

-  • Areas where the register will be subject to large amounts of humidity or dust, or directly exposed to hot or cold air.
- Areas exposed to direct sunlight, in a close motor vehicle, or any other area subject to very high temperatures.

The above conditions can cause malfunction, which creates the danger of fire.

-  • Do not overlay bend the power cord, do not allow it to be caught between desks or other furniture, and never place heavy objects on top of the power cord. Doing so can cause short circuit or breaking of the power cord, creating the danger of fire and electric shock.

-  • Be sure to grasp the plug when unplugging the power cord from the wall outlet. Pulling on the cord can damage it, break the wiring, or cause short, creating the danger of fire and electric shock.

-  • Never touch the plug while your hands are wet. Doing so creates the danger of electric shock. Pulling on the cord can damage it, break the wiring, or cause short, creating the danger of fire and electric shock.

-  • At least once a year, unplug the power plug and use a dry cloth or vacuum cleaner to clear dust from the area around the prongs of the power plug.

Never use detergent to clean the power cord, especially power plug.

-  • Keep small parts out of the reach of small children to make sure it is not swallowed accidentally.

To use the cash register's basic function

Caution

Only use the specified batteries.



- Do not disassemble, modify or short-circuit them.
- Do not put them in fire or water or heat them.
- Do not mix new and old batteries or different types of batteries.
- Orient the terminals +- correctly.
- Remove the batteries if the system will not be used for a long time.
- After batteries are spent, dispose of them as per local regulations.
- Do not try to recharge dry cell batteries.

Disposing of batteries:



- Make sure that you dispose of used batteries in accordance with the rules and regulations in your local area.

To use the cash register's basic function

■ When the cash drawer does not open!

In case of power failure or the machine is in malfunction, the cash drawer does not open automatically. Even in these cases, you can open the cash drawer by pulling drawer release lever (see below).

Important: The drawer will not open, if it is locked with a drawer lock key.

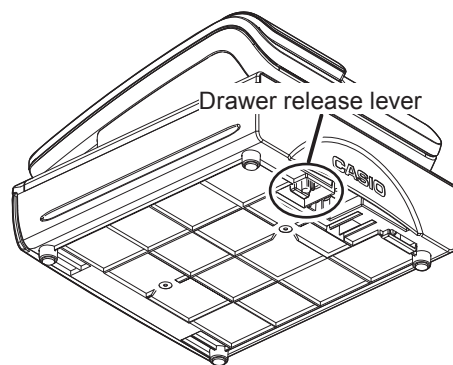

LIMITED WARRANTY : ELECTRONIC CASH REGISTERS

This product, except the battery, is warranted by CASIO to the original purchaser to be free from defects in material and workmanship under normal use for a period, from the date of purchase, of one year for parts and 90 days for labor. For one year, upon proof of purchase, the product will be repaired or replaced (with the same or a similar model) at CASIO's option, at a CASIO Authorized Service Center without charge for parts. Labor will be provided without charge for 90 days. The terminal resident software and programmable software, if any, included with this product or any programmable software which may be licensed by CASIO or one of its authorized dealers, is warranted by CASIO to the original licensee for a period of ninety (90) days from the date of license to conform substantially to published specifications and documentation provided it is used with the CASIO hardware and software for which it is designed.

For a period of ninety (90) days, upon proof of license, CASIO will, at its option, replace defective terminal resident software or programmable software, correct significant program errors, or refund the license fee for such software. Significant program errors will be significant deviations from written documentation or specifications. These are your sole remedies for any breach of warranty. In no event will CASIO's liability exceed the license fee, if any, for such software. This warranty will not apply if the product has been misused, abused, or altered.

Without limiting the foregoing, battery leakage, bending of the unit, a broken display tube, and any cracks or breaks in the display will be presumed to have resulted from misuse or abuse. To obtain warranty service you must take or ship the product, freight prepaid, with a copy of the sales receipt or other proof of purchase and the date of purchase, to a CASIO Authorized Service Center. Due to the possibility of damage or loss, it is recommended when shipping the product to a CASIO Authorized Service Center that you package the product securely and ship it insured. CASIO HEREBY EXPRESSLY DISCLAIMS ALL OTHER WARRANTIES, EXPRESS OR IMPLIED, INCLUDING ANY IMPLIED WARRANTY OF MERCHANTABILITY OR OF FITNESS FOR A PARTICULAR PURPOSE. NO RESPONSIBILITY IS ASSUMED FOR ANY INCIDENTAL OR CONSEQUENTIAL DAMAGES, INCLUDING WITHOUT LIMITATION DAMAGES RESULTING FROM MATHEMATICAL INACCURACY OF THE PRODUCT OR LOSS OF STORED DATA. SOME STATES DO NOT ALLOW THE EXCLUSION OR LIMITATION OF INCIDENTAL OR CONSEQUENTIAL DAMAGES, SO THE ABOVE LIMITATIONS OR EXCLUSIONS MAY NOT APPLY TO YOU.

This warranty gives you specific rights, and you may also have other rights which vary from state to state.

To use the cash register's basic function



Manufacturer: CASIO COMPUTER CO., LTD.
6-2, Hon-machi 1-chome, Shibuya-ku, Tokyo 151-8543, Japan
Responsible within the European Union: CASIO EUROPE GmbH
CASIO-Platz 1, 22848 Norderstedt, Germany

Please keep all information for future reference.
The declaration of conformity may be consulted at <http://world.casio.com/>



This mark applies in EU countries only.

This product is also designed for IT power distribution system with phase-to-phase voltage 230 V.

Laite on liitettävä suojamaadoituskostkettimilla vaurstettuun pistorasiaan
Apparatet må tilkoples jordat stikkontakt
Apparaten skall anslutas till jordat nätuttag.

The main plug on this equipment must be used to disconnect mains power.
Please ensure that the socket outlet is installed near the equipment and shall be easily accessible.

WARNING

THIS IS A CLASS A PRODUCT. IN A DOMESTIC ENVIRONMENT THIS PRODUCT MAY CAUSE RADIO INTERFERENCE IN WHICH CASE THE USER MAY BE REQUIRED TO TAKE ADEQUATE MEASURES.

GUIDELINES LAID DOWN BY FCC RULES FOR USE OF THE UNIT IN THE U.S.A. (Not applicable to other areas)

WARNING: This equipment has been tested and found to comply with the limits for a Class A digital device, pursuant to Part 15 of the FCC Rules. These limits are designed to provide reasonable protection against harmful interference when the equipment is operated in a commercial environment. This equipment generates, uses, and can radiate radio frequency energy and, if not installed and used in accordance with the instruction manual, may cause harmful interference to radio communications. Operation of this equipment in a residential area is likely to cause harmful interference in which case the user will be required to correct the interference at his own expense.

FCC WARNING: Changes or modifications not expressly approved by the party responsible for compliance could void the user's authority to operate the equipment.

To use the cash register's basic function

Getting started	E-10
Loading memory protection batteries.....	E-10
Installing paper roll	E-11
Setting date, time, and tax table	E-13
Getting to know your cash register	E-14
General guide.....	E-14
To adjust the main display	E-15
To set the customer display	E-15
Display	E-16
Keyboard	E-17
How to read the printouts	E-19
How to use your cash register	E-20
Before opening your store	E-21
Checking the time and date.....	E-21
Preparing bills and coins for change	E-21
Registering items in departments	E-22
Basic setups and registrations	E-26
To program basic settings.....	E-26
Programming departments	E-28
Registering departments' preset data.....	E-29
Programming PLUs	E-31
Registering PLUs' preset data.....	E-32
Other registrations	E-36
Discount	E-36
Reduction	E-37
Registering various payment methods	E-38
Tax shift	E-40
Registering returned goods	E-41
Registrations without transactions	E-43
Corrections	E-44
Daily sales reports	E-48
Print out of daily sales report.....	E-49

To use the cash register's basic function

Getting started

This chapter shows how to setup the cash register and get it ready to operate.

Loading memory protection batteries

Important: These batteries protect information stored in your cash register's memory when there is a power failure or when you unplug the cash register. Be sure to install these batteries first.

1 Remove the printer cover.



2 Remove the battery compartment cover.

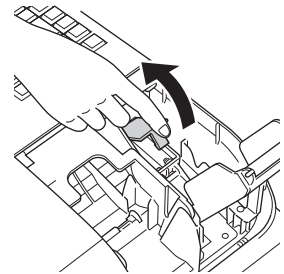

3 Note the (+) and (-) markings in the battery compartment. Load a set of two new "AA" type manganese batteries so that their plus (+) and minus (-) ends are facing as indicated by the markings.

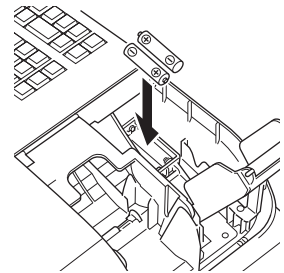

4 Replace the battery compartment cover and the printer cover.

Warning

- No battery is included in the accessories.
- Never try to recharge the batteries.
- Do not expose batteries to direct heat, let them become shorted or try to take them apart.
- Keep batteries out of the reach of small children. If your child should swallow a battery, consult a physician immediately.
- There is a risk of explosion if the batteries are replaced with improper type.
- Dispose of used batteries according to the instructions.

To use the cash register's basic function

Installing paper roll

Caution (in handling the thermal paper)

- Never touch the printer head and the platen.
- Unpack the thermal paper just before your use.
- Avoid heat and direct sunlight.
- Avoid dusty and humid places for storage.
- Do not scratch the paper.
- Do not keep the printed paper under the following circumstances:
- High humidity and temperature/direct sunlight/contact with glue, thinner or a rubber eraser.

■ To install receipt paper

- 1** Remove the printer cover.
- 2** Open the platen arm by lifting it up.
- 3** Ensuring the paper is being fed from the bottom of the roll, lower the roll into the space behind the printer.
- 4** Put the leading end of the paper over the printer.
- 5** Close the platen arm slowly until it locks securely.
- 6** Replace the printer cover, passing the leading end of the paper through the cutter slot. Tear off the excess paper.

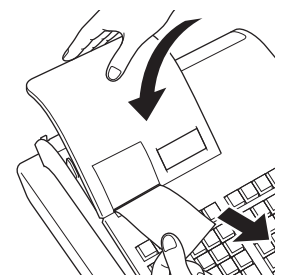
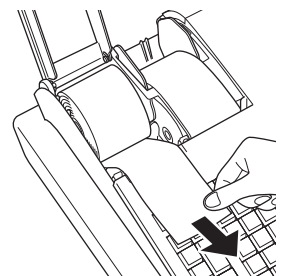
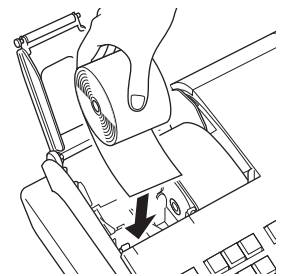
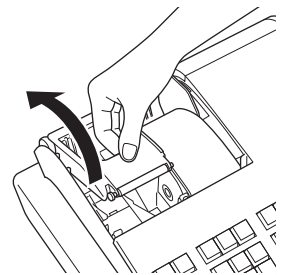

To use the cash register's basic function

■ To install journal paper

- 1** By the same procedure of setting receipt paper, set journal paper on the journal printer.
- 2** Using  key, feed the paper about 20 cm
- 3** Remove the paper guide of the take-up reel.

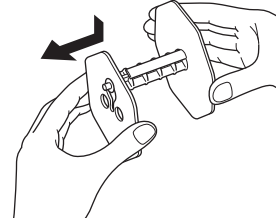

- 4** Slide the leading end of the paper into the groove on the spindle of the take-up reel and wind it onto the reel two or three turns.

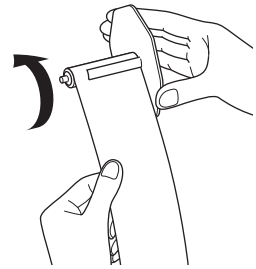

- 5** Replace the paper guide of the take-up reel.

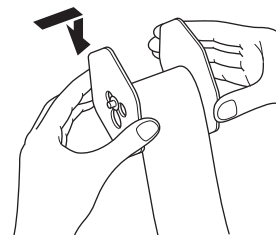

- 6** Place the take-up reel into place behind the printer, above the roll paper.

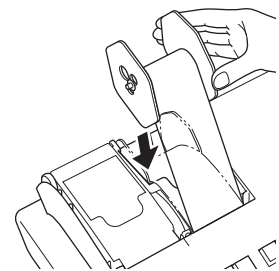

- 7** Press the  key to take up any slack in the paper.
- 8** Replace the printer cover.

To use the cash register's basic function

Setting date, time, and tax table

1 Plug in the power socket into a wall outlet.

Be sure to check the rating plate on the side of the cash register to make sure that its voltage matches that of the power supply in your area.

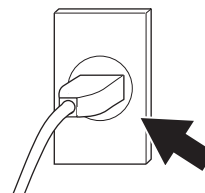

2 As soon as the power socket is plugged in, the display shows the language selection display. Choose your language by using or keys then press key.

```
PLEASE SELECT LANGUAGE.
<CA/AMT TEND>           :ENTER

English
Español
```

3 Display changes to date and time setting display. Moving the input area (reversed area) by or keys, input date, month, year and time from ten key pad. Input the time by 24 - hour system. For example, 1356 for 1:56 pm. After then press key.

```
PLEASE INPUT DATE & TIME.
<CA/AMT TEND>           :ENTER
<SUBTOTAL>             :RETURN

DATE                    [DD]
MONTH                   [MM]
YEAR                    [YYYY]
TIME(24-hour)           [HHMM]
```

4 Display then changes to tax table selection display. Select your state by or keys and press key.

For the Canadian model, skip the following step and see page E-66 for setting Canadian rounding.

```
PLEASE SELECT TAX TABLE.
<CA/AMT TEND>           :ENTER
<SUBTOTAL>             :RETURN

ALABAMA
ALASKA
ARIZONA
ARKANSAS
CALIFORNIA
```

5 Select TABLE 1 or 2 and press key.

```
PLEASE SELECT TAX TABLE.
<CA/AMT TEND>           :ENTER
<SUBTOTAL>             :RETURN

ALASKA
TABLE 1                 [NON SELECT ]
TABLE 2                 [NON SELECT ]
                        END
```

6 Select tax rate and your area and press key.

```
PLEASE SELECT TAX TABLE.
<CA/AMT TEND>           :ENTER
<SUBTOTAL>             :RETURN

ALASKA                  TABLE 1
  2% KANAI
  3%
  3% HOMER
  4% HAINES
  4% JUNEAU
```

To use the cash register's basic function

Getting to know your cash register

General guide

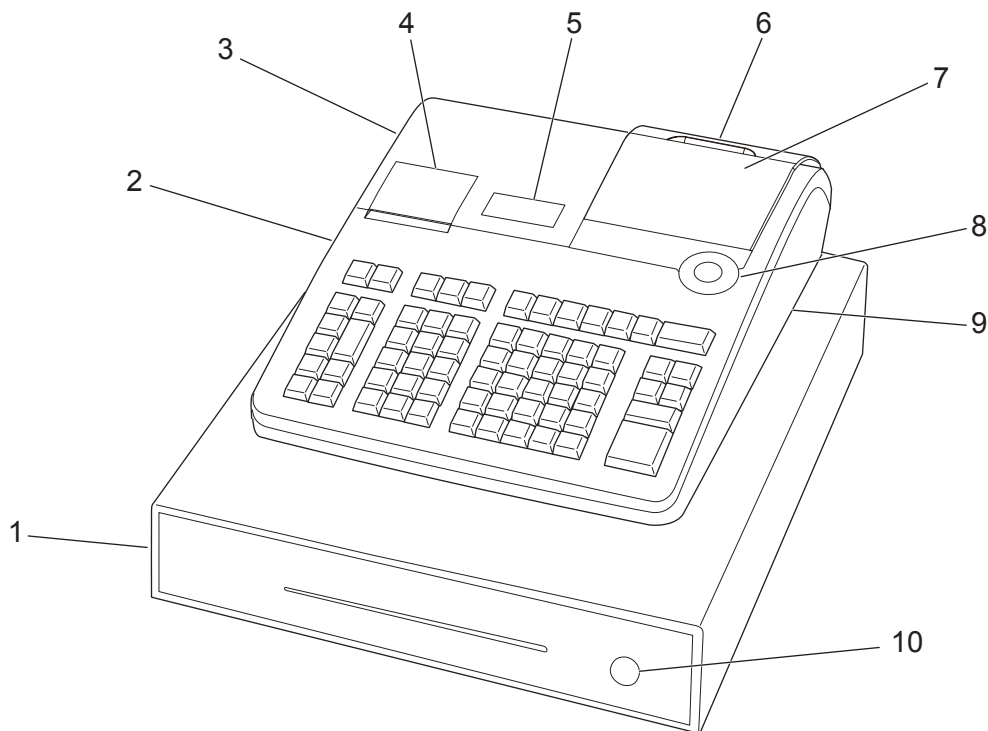

- | | | | |
|---|--------------------|----|--------------------------|
| 1 | Drawer | 6 | Customer display |
| 2 | SD card slot cover | 7 | Main display |
| 3 | Printer cover | 8 | Mode switch |
| 4 | Receipt printer | 9 | Com port connector cover |
| 5 | Journal printer | 10 | Drawer lock |

Mode switch

Use the mode keys to change the position of the mode switch and select the mode you want to use.

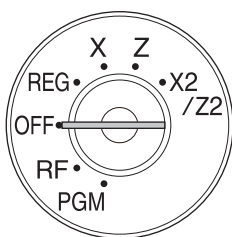

PGM (Programming)

This position is for setting your cash register to suit the needs of your store.

RF (Refund)

Use this position to correct registered items.

OFF

The cash register turns off in this position.

REG (Register)

This position is for normal transactions.

X (Read)

This is the position used for issuing daily sales totals report without clearing the data.

Z (Reset)

This position is for issuing reports of daily totals with clearing the accumulated totals.

X2/Z2 (Periodic sale read/reset)

Used to obtain periodic sales reports without resetting total data.

To use the cash register's basic function

Mode keys

There are two types of mode keys: the program key (marked "PGM") and the operator key (marked "OP"). The program key can be used to set the mode switch to any position, while the operator key can select the REG and OFF position.

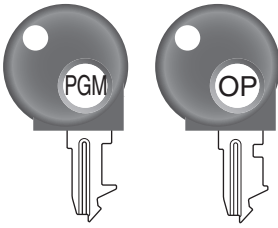

	PGM	RF	OFF	REG	X	Z	X2/Z2
OP key	-	-	○	○	-	-	-
PGM key	○	○	○	○	○	○	○

Drawer

The drawer opens automatically whenever you finalize a registration and whenever you issue a read or reset report. The drawer will not open if it is locked with the drawer key.

Drawer key

Use this key to lock and unlock the drawer.

Magnetic plate

Use this plate for tacking the notes received from customer.

To adjust the main display

- 1 Put in fingers in the ditch of the main display and tilt it to the angle you can see clearly.

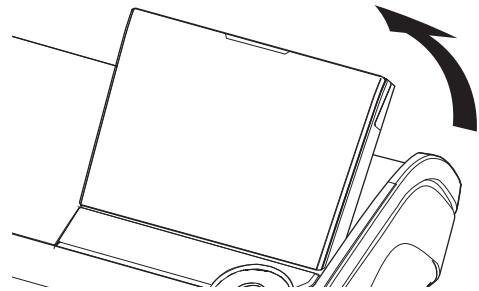

To set the customer display

- 1 Lift the customer display until it stops.

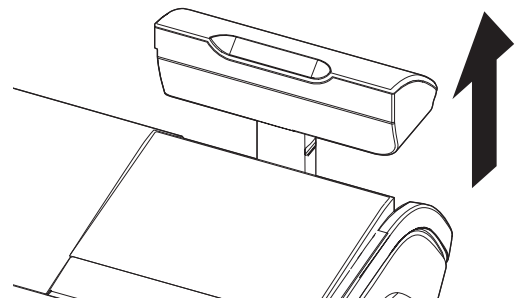

- 2 Rotate the display so that customers can see it.

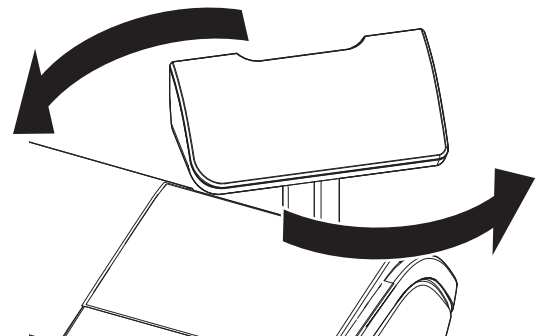

To use the cash register's basic function

Display

■ Main display

During a registration

CLERK001	REG	000011	1
1	PLU001	\$1.00	2
3	DEPT001	\$6.00	
SUBTOTAL		\$7.00	3
QT	4	6.00	4

After finalization

CLERK001	REG	000011	
1	PLU001	\$1.00	
3	DEPT001	\$6.00	
	TL	\$7.00	5
	CASH	\$10.00	6
	CG	\$3.00	7
CG		\$3.00	8
QT	4	\$10.00	9

- | | |
|---|----------------------------------|
| 1 Mode/Clerk Number or name/Consecutive No. | 5 Total amount |
| 2 Registered item Quantity/Category/Price | 6 Paid by/Tendered amount |
| 3 Subtotal amount | 7 Change |
| 4 Total quantity/Price of the last item | 8 Change |
| | 9 Total quantity/Tendered amount |









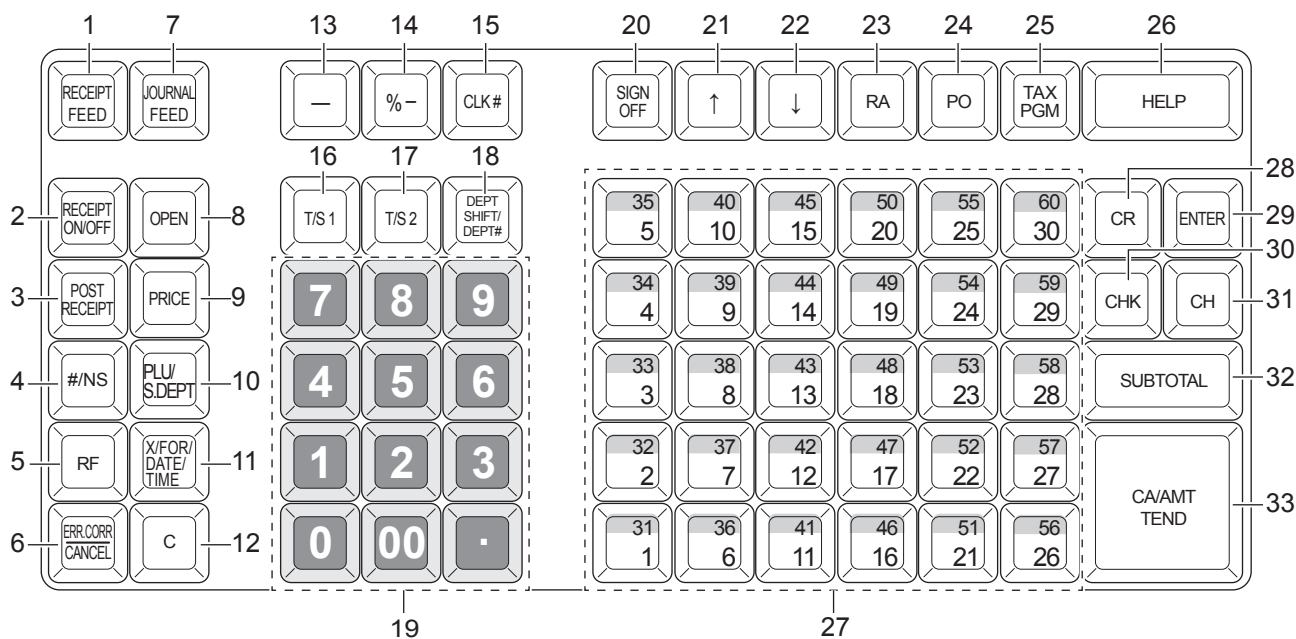







■ Customer display



























To use the cash register's basic function

Keyboard



- 1  Hold this key down to feed receipt paper from the printer.
- 2  Use this key to switch issuing receipts on and off.
- 3  Use this key to issue a post-finalization receipt.
- 4  Non-add key: Use this key to print reference number (to identify a personal check, credit card, etc.) during a transaction. Use this function after a numeral entry. No sale key: Use this key to open the drawer without any registration.
- 5  Use this key to input refunded amounts or to void preceding inputs.
- 6  Use this key to correct registration errors or to cancel a transactions.
- 7  Hold this key down to feed journal paper from the printer.
- 8  Use this key to temporarily release a limitation on the number of digits for a unit price.
- 9  Use this key to register unit prices for a PLU (subdepartment).
- 10  Use this key to input PLU (subdepartment) numbers.
- 11  Use this key to input a quantity for a multiplication and registration of split sales of packaged items. Between transactions, pressing this key displays the current time and date.
- 12  Use this key to clear an entry that has not yet been registered.
- 13  Use this key to input reduction values.
- 14  Use this key to register discounts.
- 15  Use this key to input a clerk number.
- 16  Use this key without a numeric entry to change the taxable 1 status of the following item.

To use the cash register's basic function

- 17  Use this key without a numeric entry to change the taxable 2 status of the following item.
- 18  Department no. Use this key to input department numbers. Department shift: Use this key to shift the department number from 1 through 30 to 31 through 60.
- 19     Use these keys to input numbers.
- 20  Use this key to sign clerk off the register.
- 21  Use this key to move the cursor on the display up.
- 22  Use this key to move the cursor on the display down.
- 23  Use this key following a numeric entry to register money received for non-sale transactions.
- 24  Use this key following a numeric entry to register money paid out from the drawer.
- 25  Use this key to set the tax status and tax table.
- 26  Use this key to look up the procedures to set date/time, tax table etc.
- 27  to  Use these keys to register items to departments.
 to : NON TAX  to : NON TAX
- 28  Use this key to register a credit sale.
- 29  Not used for regular registrations.
- 30  Use this key to register a check tendering.
- 31  Use this key to register a charge sale.
- 32  Use this key to display and print the current subtotal (including tax) amount.
- 33  Use this key to register a cash sale.

To use the cash register's basic function

How to read the printouts

- The journal/receipts are records of all transactions and operations.
- The contents printed on receipts and journal are almost identical.
- You can choose the journal skip function.
If the journal skip function is selected, the cash register will print the total amount of each transaction, and the details of premium, discount and reduction operations only, without printing department and PLU item registrations on the journal.
- The following items can be skipped on receipts and journal.
 - Taxable status
 - Taxable amount
 - Item counter

Receipt Sample

```

*****
* THANK YOU *
** CALL AGAIN **
*****

* COMMERCIAL MESSAGE *
* COMMERCIAL MESSAGE *
* COMMERCIAL MESSAGE *
* COMMERCIAL MESSAGE *

New Year
Sale
1st Anniversary
10% OFF



REG 20-06-2013 11:58
C01 0001 000123

1 DEPT001 T1 $1.00
1 DEPT002 T1 $2.00
5 DEPT003 $5.00
7 No
TA1 $3.00
TX1 $0.15
TL $8.15
CASH $10.00
CG $1.85

*** BOTTOM MESSAGE ***
*** BOTTOM MESSAGE ***
*** BOTTOM MESSAGE ***
*** BOTTOM MESSAGE ***
    
```

Journal Sample (with items)

```

REG 20-06-2013 11:58
C01 0001 000123
1 DEPT001 T1 $1.00
1 DEPT002 T1 $2.00
5 DEPT003 $5.00
7 No
TA1 $3.00
TX1 $0.15
TL $8.15
CASH $10.00
CG $1.85

REG 20-06-2013 11:59
C01 0001 000124
1 DEPT001 T1 $1.00
1 DEPT012 T1 $1.00
5 DEPT003 $6.00
7 No
TA1 $2.00
TX1 $0.10
TL $3.10
CASH $10.00
CG $1.90

REG 20-06-2013 11:59
C01 0001 000124
    
```

Journal Sample (by half height character)

```

REG 20-06-2013 11:58
C01 0001 000123
1 DEPT001 T1 $1.00
1 DEPT002 T1 $2.00
5 DEPT003 $5.00
7 No
TA1 $3.00
TX1 $0.15
TL $8.15
CASH $10.00
CG $1.85

REG 20-06-2013 11:59
C01 0001 000124
1 DEPT001 T1 $1.00
1 DEPT012 T1 $1.00
5 DEPT003 $6.00
7 No
TA1 $2.00
TX1 $0.10
TL $3.10
CASH $10.00
CG $1.90

REG 20-06-2013 11:59
C01 0001 000124
    
```

- | | |
|----------------------|-------------------------------------|
| 1 Logo message | 6 Clerk/Machine No./Consecutive No. |
| 2 Commercial message | 7 Q'ty/Item |
| 3 Preset message * | 8 Item counter |
| 4 Preset graphic * | 9 Bottom message |
| 5 Mode/Date/Time | |

* You can choose to print preset message and graphic at the top or the bottom of the receipt. (See page E-27)

In the operation examples in this manual, the printout samples are what would be printed on receipts.

To use the cash register's basic function

How to use your cash register

The following describes the general procedure you should use in order to get the most out of your cash register.

Before opening your store



- Plugged in? (page E-13)
- Enough paper roll? (pages E-11 and E-12)
- Date and time are correct? (pages E-21 and E-26)
- Enough small change in the drawer? (page E-21)



While the store is open



- Registrations (page E-22)
- Issuing latest total sales report if needed. (page E-47)



After closing the store



- Issuing day's total sales report. (page E-47)
- Withdraw the money from the drawer.
After you withdraw all the money from the drawer, we recommend that you leave the drawer open when you leave your store. (page E-21)
- Turn the Mode switch to OFF. (page E-14)

To use the cash register's basic function

Before opening your store

Checking the time and date

You can check the time or date on the display whenever there is no registration being made.

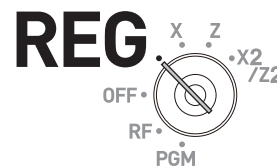

Step	Operation	Display
1 Press key to show the date and time on the display.		
2 Press key to clear the date/time display.		

Preparing bills and coins for change

To prepare coins and bills for change, you can open the drawer by pressing key. This operation must be performed when registrations are not being made.



NOTE Opening the drawer by key does not perform any calculation in the register. If you wish to obtain a report that tells you the total amount in drawer, use key instead of key. See page E-43.

Step	Operation	Printout
1 Press . The cash drawer opens.		
2 Prepare coins and bills in the drawer.		

To use the cash register's basic function

Registering items in departments

The following examples show how you can use the department keys in various types of registrations.

Departments are used for categorizing items for example, department 01 for vegetables, department 02 for fruits, and department 03 for canned foods etc.

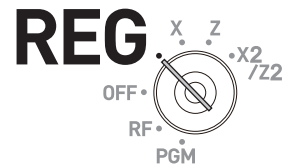

■ Single item sale

Sample Operation

Item	Unit Price	\$1.00	One \$1.00 Dept. 01 item is sold and the customer paid the same amount as the total amount.
	Quantity	1	
	Dept.	01	
Payment	Cash	\$1.00	

Step	Operation	Printout						
1 Enter the unit price.	1 00	<table border="1"> <tr> <td>1 DEPT001</td> <td>\$1.00</td> </tr> <tr> <td>TL</td> <td>\$ 1.00</td> </tr> <tr> <td>CASH</td> <td>\$1.00</td> </tr> </table>	1 DEPT001	\$1.00	TL	\$ 1.00	CASH	\$1.00
1 DEPT001	\$1.00							
TL	\$ 1.00							
CASH	\$1.00							
2 Press corresponding department key.	1							
3 Press CA / AMT / TEND key.	CA / AMT / TEND							

Further operations:

- For simpler operation of single item sales, see page E-53

■ Single item sales with change calculation

Sample Operation

Item	Unit Price	\$12.34	One item is sold and the customer paid more than the total amount.
	Quantity	1	
	Dept.	01	
Payment	Cash	\$20.00	

Step	Operation	Printout								
1 Enter the unit price.	1 2 3 4	<table border="1"> <tr> <td>1 DEPT001</td> <td>\$12.34</td> </tr> <tr> <td>TL</td> <td>\$ 12.34</td> </tr> <tr> <td>CASH</td> <td>\$20.00</td> </tr> <tr> <td>CG</td> <td>\$7.66</td> </tr> </table>	1 DEPT001	\$12.34	TL	\$ 12.34	CASH	\$20.00	CG	\$7.66
1 DEPT001	\$12.34									
TL	\$ 12.34									
CASH	\$20.00									
CG	\$7.66									
2 Press corresponding department key.	1									
3 Press SUB TOTAL key.	SUB TOTAL									
4 Enter the tendered amount then press CA / AMT / TEND key. The display shows the change to be paid.	2 0 00 CA / AMT / TEND									

To use the cash register's basic function

Repeat registration

Sample Operation

Item	Unit Price	\$1.50	Same priced multiple items are sold.
	Quantity	3	
	Dept.	1	
Payment	Cash	\$10.00	

Step	Operation	Printout												
1 Enter the unit price.	1 5 0	<table border="1"> <tr><td>1 DEPT001</td><td>\$1.50</td></tr> <tr><td>1 DEPT001</td><td>\$1.50</td></tr> <tr><td>1 DEPT001</td><td>\$1.50</td></tr> <tr><td>TL</td><td>\$4.50</td></tr> <tr><td>CASH</td><td>\$10.00</td></tr> <tr><td>CG</td><td>\$5.50</td></tr> </table>	1 DEPT001	\$1.50	1 DEPT001	\$1.50	1 DEPT001	\$1.50	TL	\$4.50	CASH	\$10.00	CG	\$5.50
1 DEPT001	\$1.50													
1 DEPT001	\$1.50													
1 DEPT001	\$1.50													
TL	\$4.50													
CASH	\$10.00													
CG	\$5.50													
2 Press corresponding department key repeatedly for the purchased quantity.	1 1 1													
3 Press SUB TOTAL key.	SUB TOTAL													
4 Enter the tendered amount then press CA / AMT TEND key. The display shows the change to be paid.	1 0 00 CA / AMT TEND													

Multiple items registration using multiplication key

Sample Operation

Item	Unit Price	\$1.00	Twelve pieces of \$1.00 item are sold and the customer paid more than the total amount.
	Quantity	12	
	Dept.	1	
Payment	Cash	\$20.00	

















Step	Operation	Printout								
1 Enter the the quantity then press X / FOR DATE TIME key.	1 2 X / FOR DATE TIME	<table border="1"> <tr><td>12 DEPT001</td><td>\$12.00</td></tr> <tr><td>TL</td><td>\$12.00</td></tr> <tr><td>CASH</td><td>\$20.00</td></tr> <tr><td>CG</td><td>\$8.00</td></tr> </table>	12 DEPT001	\$12.00	TL	\$12.00	CASH	\$20.00	CG	\$8.00
12 DEPT001	\$12.00									
TL	\$12.00									
CASH	\$20.00									
CG	\$8.00									
2 Enter the unit price and press corresponding department key.	1 00 1									
3 Press SUB TOTAL key.	SUB TOTAL									
4 Enter the tendered amount then press CA / AMT TEND key. The display shows the change to be paid.	2 0 00 CA / AMT TEND									

To use the cash register's basic function

■ Split sales of packaged items

Sample Operation

Item	Unit Price	4 for \$10.00	Three pieces of an item that's price is \$10.00 for four pieces are sold.
	Quantity	3	
	Dept.	1	
Payment	Cash	\$10.00	











Step	Operation	Printout								
1 Enter purchased quantity then press  key.	 	<table border="1"> <tr> <td>3 DEPT001</td> <td>\$7.50</td> </tr> <tr> <td>TL</td> <td>\$7.50</td> </tr> <tr> <td>CASH</td> <td>\$10.00</td> </tr> <tr> <td>CG</td> <td>\$2.50</td> </tr> </table>	3 DEPT001	\$7.50	TL	\$7.50	CASH	\$10.00	CG	\$2.50
3 DEPT001	\$7.50									
TL	\$7.50									
CASH	\$10.00									
CG	\$2.50									
2 Enter the quantity of one set and press  key.	 									
3 Enter the package price and press corresponding department and  keys.	    									
4 Enter the tendered amount and press  key.	   									

■ Department shift

By using , Dept. 01 through 30 are assigned to Dept. 31 through 60.

Sample Operation

Item	Unit Price	\$1.00	Department 31 is assigned by using  key.
	Quantity	1	
	Dept.	31	
Payment	Cash	\$1.00	

Step	Operation	Printout						
1 Press  key. "SHIFT/No" will be shown at the bottom of the display.		<table border="1"> <tr> <td>1 DEPT031</td> <td>\$1.00</td> </tr> <tr> <td>TL</td> <td>\$1.00</td> </tr> <tr> <td>CASH</td> <td>\$1.00</td> </tr> </table>	1 DEPT031	\$1.00	TL	\$1.00	CASH	\$1.00
1 DEPT031	\$1.00							
TL	\$1.00							
CASH	\$1.00							
2 Enter the unit price and press corresponding department key. Then press  key. The item is registered in Dept. 31 in this example.	    							
3 Press  key to finalize the transaction.								

To use the cash register's basic function

■ Department number entry

Without using Department key, you can register departments manually.

Sample Operation

Item	Unit Price	\$13.00	Registering an item in Dept. 31 without using Department key.
	Quantity	1	
	Dept.	31	
Payment	Cash	\$13.00	

Step

Operation

Printout

1 Enter Dept. number using ten key pad then press  key.

3 **1** 

2 Enter the unit price and press  key. Then press  key.

1 **3** **00**  

1 DEPT031	\$13.00
TL	\$13.00
CASH	\$13.00

The item is registered in Dept. 31 in this example.

3 Press  key to finalize the transaction.



To use the cash register's basic function

Basic setups and registrations

To program basic settings

You can program basic settings in the PGM mode of the Mode switch.



Step

Display

- By turning the Mode switch to PGM position, the display indicates the programming top menu.
- Use or keys to choose the item you wish to set then press key.
Repeat the above step until the display shows an entry display.
- Input values you wish to set and press key.

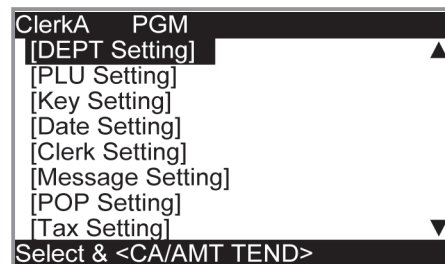

The following table shows the setting items of the basic programming.

■ Program menus

Top menu	Sub menu	What is to be set
[DEPT Setting]	DEPT name [DEPT0001]	Sets name, unit price, taxable status, item group and high amount limitation in each department. See page E-28.
	Unit Price [12.00]	
	Taxable Status [1&2]	
	Group Link [03]	
	HAL (High amount limit) [0.00]	
[PLU Setting]	PLU name [PLU0001]	Sets name, unit price, taxable status, item group, department link and open PLU in each PLU. See page E-31.
	Unit Price [12.00]	
	Taxable Status [1&2]	
	Group Link [03]	
	DEPT Link [003]	
	Open PLU [Yes]	
[Key Setting]	%- []	Sets name, taxable status, and whether to use taxable status or not in each function key.
	- RATE []	
	Taxable Status []	
[Date Setting]	TIME (24 HOUR) [19:56]	Sets date and time.
	MONTH [12]	
	DAY [26]	
	YEAR 20[12]	
[Clerk Setting]	Name [CLERK01]	Sets clerk's name and number.
	Secret No [1234]	

To use the cash register's basic function

Top menu	Sub menu	What is to be set
[Message Setting]	01 Logo 1	Sets logo, commercial, and bottom messages on receipts. See page E-59.
	02 Logo 2	
	03 Logo 3	
	04 Logo 4	
	05 Commercial 1	
	06 Commercial 2	
	07 Commercial 3	
	08 Commercial 4	
	01 Bottom 1	
	02 Bottom 2	
	03 Bottom 3	
	04 Bottom 4	
[POP Setting]	POP Message No. 1 []	Sets preset pop messages and illustration. See page E-59.
	POP Message No. 2 []	
	POP Message No. 3 []	
	POP Message No. 4 []	
	POP Graphic No.[]	
	POP Print	
	All Message	
	All Graphic	
[Tax Setting]	[RATE]	
	[ROUND]	
	[CAL TYPE]	
[General Setting]	Enable clerk	Sets general controls of the register such as clerk assignment, printing journal in half size etc.
	Journal 1/2 Print	
	Consecutive No. Reset [Yes]	
	EJ clear (After Daily Z) [Yes]	
	EJ/Sales→SD (After XZ) [Yes]	
[Water Mark Setting]	YES	
	NO	
[SD card]	[Backup → SD]	Exchanges sales data, program data, and receipt's message data between the register and an SD card. See page E-96.
	[Restore← SD]	
	[Program→ SD]	
	[Program← SD]	
	[SD Format]	
	[Backup → Flash]	
	[AutoProgram→ SD]	
	[AutoProgram← SD]	
[System Setting]		Used to set characters, functions of keys, or calculation methods etc.

To use the cash register's basic function

Programming departments

This section explains how you can set unit prices, taxable statuses, and item groups. You can program each department linking to a certain group. For example, department 01 is for packed milk, department 02 is for cheese and both belong to group 03 (dairy goods).

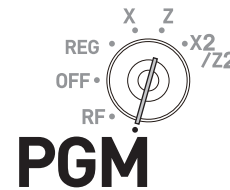

Sample Operation

Dept. 01	Unit Price	\$2.50	Programming Dept. 01 as unit price \$2.50, non taxable, belonging to Group 02.
	Taxable status	Non tax	
	Group	02	

Step

1 Turn the Mode switch to PGM position. The display shows the top screen of programming.

2 Using or keys, select [DEPT Setting] then press key. The display shows [DEPT Setting] screen.

3 Enter the department number (01 in this example) then press key. The display shows department selection screen. You can change the department by using or keys.

4 Press key. The display shows program input screen. Input unit price and group link you wish to program. The top column is for setting characters to the dept. You can leave the column empty. If you wish to set characters now, please see page E-55.

5 Select [Taxable Status] and press key. The display shows taxable status selection screen. Choose the taxable status and press key.

Display

```
ClerkA  PGM
[DEPT Setting]
[PLU Setting]
[Key Setting]
[Date Setting]
[Clerk Setting]
[Message Setting]
[POP Setting]
[Tax Setting]
Select & <CA/AMT TEND>
```

```
DEPT Setting
Input DEPT No.
DEPT No.      [      ]
Select & <CA/AMT TEND> or
Cancel <SUB TOTAL>
```

```
DEPT Setting
0001. DEPT001
0002. DEPT002
0003. DEPT003
0004. DEPT004
0005. DEPT005
0006. DEPT006
0007. DEPT007
Select & <CA/AMT TEND> or
Cancel <SUB TOTAL>
```

```
DEPT Setting
0001. [ DEPT0001 ]
Unit Price [ $0.00 ]
Taxable Status [ NON TAX ]
Group Link [ 00 ]
HAL [ $0.00 ]
[ $0.00 ]
Select & <CA/AMT TEND> or
Cancel <SUB TOTAL>
```

```
DEPT Setting
Taxable Status
[ NON TAX ]
[ T/S1 ]
[ T/S2 ]
[ T/S1&2 ]
[ T/S3 ]
[ T/S1&3 ]
Select & <CA/AMT TEND> or
Cancel <SUB TOTAL>
```

To use the cash register's basic function

NOTE The display returns to the previous screen by pressing  key.

Registering departments' preset data

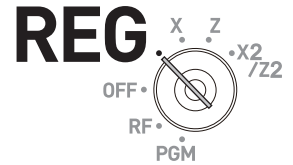

The following examples explain the operations using preset department data programmed in the previous section.



■ Using preset prices

Sample Operation

Item	Unit Price	\$2.50	Unit price \$2.50 is preset in Dept. 02.
	Quantity	1	
	Dept.	02	
Payment	Cash	\$2.50	

Step	Operation	Printout						
1 Just press the corresponding Department key.		<div style="border: 1px solid black; padding: 5px;"> <table style="width: 100%; border-collapse: collapse;"> <tr> <td style="width: 60%;">1 DEPT002</td> <td style="text-align: right;">\$2.50</td> </tr> <tr> <td>TL</td> <td style="text-align: right;">\$2.50</td> </tr> <tr> <td>CASH</td> <td style="text-align: right;">\$2.50</td> </tr> </table> </div>	1 DEPT002	\$2.50	TL	\$2.50	CASH	\$2.50
1 DEPT002	\$2.50							
TL	\$2.50							
CASH	\$2.50							
2 Press  key to finalize the transaction.								

To use the cash register's basic function

■ Using preset tax statuses

Sample Operation

Item 1	Unit Price	\$2.00	<ul style="list-style-type: none"> • Dept. 03 presets: Unit price \$2.00, Tax status 1 (4%). • Dept. 04 presets: Unit price \$2.00, Tax status 2 (10%).
	Quantity	5	
	Dept.	03	
	Taxable	1	
Item 2	Unit Price	\$2.00	
	Quantity	1	
	Dept.	04	
	Taxable	2	
Payment	Cash	\$2.50	

Step

Operation

Printout

1 Register five pieces of Dept. 03 item using the multiplication key.



2 Press Dept. 04 key to register one \$2.00 item.



3 Press **SUB TOTAL** key to indicate the total amount including tax.



4 Enter the tendered amount and press **CA / AMT / TEND** key.



5	DEPT003	T1	\$10.00
1	DEPT004	T2	\$2.00
	TA1		\$10.00
	TX1		\$0.40
	TA2		\$2.00
	TX2		\$0.20
	TL		\$ 12.60
	CASH		\$20.00
	CG		\$7.40

To use the cash register's basic function

Programming PLUs

Like departments, you can program unit price, taxable status, and linking item group in a PLU (Price Look Up). Using PLUs allow you to register items quickly and accurately. You can use up to 7,000 PLUs.

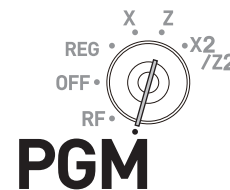

Sample Operation

PLU 0014	Unit Price	\$2.50	Programming PLU 0014 as unit price \$2.50, non taxable, belonging to Group 03.
	Taxable status	Non tax	
	Group	03	

Step

1 Turn the Mode switch to PGM position. The display shows the top screen of programming.

Display

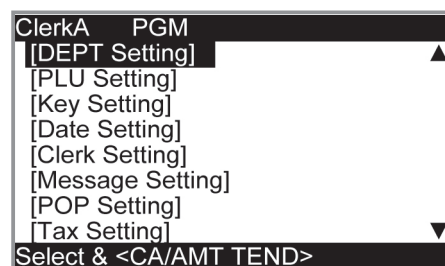

2 Using or keys, select [PLU Setting] then press key. The display shows [PLU Setting] screen.

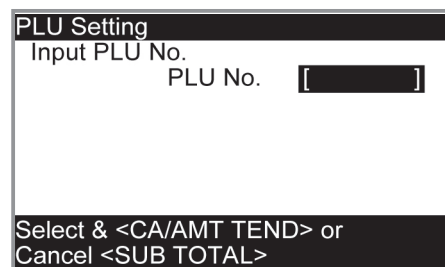

3 Enter the PLU number (0014 in this example) then press key. The display shows [PLU Setting] screen. You can change the PLU number by using or keys.

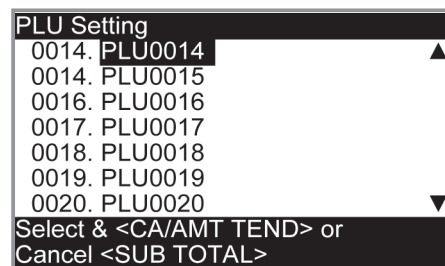

4 Press key. The display shows program input screen. Input unit price and group link you wish to program. The top column is for setting characters to the PLU. You can leave the column empty. If you wish to set characters now, please see page E-55.

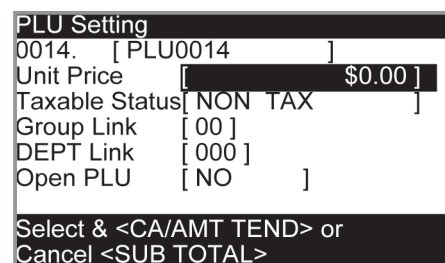

5 Select [Taxable Status] and press key. The display shows taxable status selection screen. Choose the taxable status and press key.

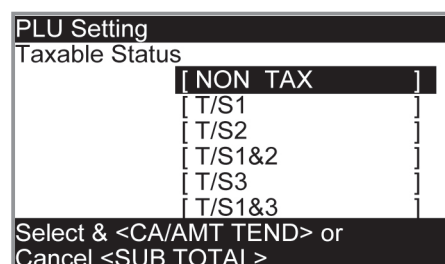

To use the cash register's basic function

NOTE The display returns to the previous screen by pressing  key.

Registering PLUs' preset data



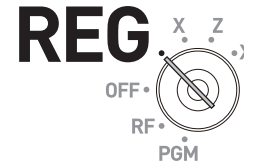



The following examples explain the operations using preset PLU data programmed in the previous section.



■ Single item sales using PLU

Sample Operation

Item	Unit Price	\$2.50	One piece of PLU number 14 (preset unit price \$2.50) is sold.
	Quantity	1	
	PLU No.	14	
Payment	Cash	\$3.00	









Step	Operation	Printout								
1 Enter the PLU number and press  key. One piece of PLU number 14 item has been registered. Then press  key.	 	<div style="border: 1px solid black; padding: 5px;"> <table style="width: 100%; border-collapse: collapse;"> <tr> <td style="width: 60%;">1 PLU0014</td> <td style="text-align: right;">\$2.50</td> </tr> <tr> <td>TL</td> <td style="text-align: right;">\$2.50</td> </tr> <tr> <td>CASH</td> <td style="text-align: right;">\$3.00</td> </tr> <tr> <td>CG</td> <td style="text-align: right;">\$0.50</td> </tr> </table> </div>	1 PLU0014	\$2.50	TL	\$2.50	CASH	\$3.00	CG	\$0.50
1 PLU0014	\$2.50									
TL	\$2.50									
CASH	\$3.00									
CG	\$0.50									
2 Enter tendered amount and press  key.										

To use the cash register's basic function

■ PLU repeat registration

Sample Operation









Item	Unit Price	\$2.50	Three pieces of PLU number 14 (preset unit price \$2.50) is sold.
	Quantity	3	
	PLU No.	14	
Payment	Cash	\$10.00	

Step	Operation	Printout												
1 Enter the PLU number.	1 4	<table border="1"> <tr><td>1 PLU0014</td><td>\$2.50</td></tr> <tr><td>1 PLU0014</td><td>\$2.50</td></tr> <tr><td>1 PLU0014</td><td>\$2.50</td></tr> <tr><td>TL</td><td>\$7.50</td></tr> <tr><td>CASH</td><td>\$10.00</td></tr> <tr><td>CG</td><td>\$2.50</td></tr> </table>	1 PLU0014	\$2.50	1 PLU0014	\$2.50	1 PLU0014	\$2.50	TL	\$7.50	CASH	\$10.00	CG	\$2.50
1 PLU0014	\$2.50													
1 PLU0014	\$2.50													
1 PLU0014	\$2.50													
TL	\$7.50													
CASH	\$10.00													
CG	\$2.50													
2 Press  key repeatedly for the number of sold quantity. Three pieces of PLU 14 have been registered. Then press  key.	   													
3 Enter the tendered amount and press  key.	1 0 00 													

■ PLU registration with multiplication key

Sample Operation

Item	Unit Price	\$2.00	Ten pieces of PLU number 7 item (preset unit price \$2.00) are sold.
	Quantity	10	
	PLU No.	7	
Payment	Cash	\$20.00	











Step	Operation	Printout								
1 Enter the quantity sold then press  key. Up to 9999.999 can be entered for multiplication calculations.	1 0 	<table border="1"> <tr><td>10 PLU0007</td><td>\$20.00</td></tr> <tr><td>TL</td><td>\$20.00</td></tr> <tr><td>CASH</td><td>\$20.00</td></tr> <tr><td>CG</td><td>\$0.00</td></tr> </table>	10 PLU0007	\$20.00	TL	\$20.00	CASH	\$20.00	CG	\$0.00
10 PLU0007	\$20.00									
TL	\$20.00									
CASH	\$20.00									
CG	\$0.00									
2 Enter the PLU number and press  key. Then press  key.	7  									
3 Enter tendered amount and press  key.	2 0 00 									

To use the cash register's basic function

■ Split sales of packaged PLU item

Sample Operation

Item	Unit Price	5 for \$20	Selling three pieces of an item that is priced \$20.00 for five pieces.
	Quantity	3	
	PLU No.	28	
Payment	Cash	\$15.00	

Step	Operation	Printout								
<p>1 Enter the quantity being purchased and press  key for multiplication calculation. You can enter up to 9999.999 for multiplication calculations.</p>	<p>3 </p>	<div style="border: 1px solid black; padding: 5px;"> <table style="width: 100%; border-collapse: collapse;"> <tr> <td style="width: 60%;">3 PLU0028</td> <td style="text-align: right;">\$12.00</td> </tr> <tr> <td>TL</td> <td style="text-align: right;">\$12.00</td> </tr> <tr> <td>CASH</td> <td style="text-align: right;">\$15.00</td> </tr> <tr> <td>CG</td> <td style="text-align: right;">\$3.00</td> </tr> </table> </div>	3 PLU0028	\$12.00	TL	\$12.00	CASH	\$15.00	CG	\$3.00
3 PLU0028	\$12.00									
TL	\$12.00									
CASH	\$15.00									
CG	\$3.00									
<p>2 Enter the packaged quantity and press  key. You can enter up to 9999.999 for packaged quantity.</p>	<p>5 </p>									
<p>3 Enter the PLU number of the item and press  key. Then press  key.</p>	<p>2 8  </p>									
<p>4 Enter the tendered amount and press  key.</p>	<p>1 5 00 </p>									













To use the cash register's basic function

■ Open PLU

Although unit price is preset in a PLU, you can enter price manually if the PLU is programmed as "Open PLU". To program open PLU, see page E-26.

Sample Operation

Item 1	Unit Price	\$32.80	PLU numbers 30 and 31 are programmed as open PLU so that the unit prices can be entered manually.
	Quantity	1	
	PLU No.	30	
Item 2	Unit Price	\$13.00	
	Quantity	2	
	PLU No.	31	
Payment	Cash	\$60.00	

Step	Operation	Printout												
1 Enter the PLU number of the first item then press  key.	3 0 	<table border="1"> <tr><td>1 PLU0030</td><td>\$32.80</td></tr> <tr><td>1 PLU0031</td><td>\$13.00</td></tr> <tr><td>1 PLU0031</td><td>\$13.00</td></tr> <tr><td>TL</td><td>\$58.80</td></tr> <tr><td>CASH</td><td>\$60.00</td></tr> <tr><td>CG</td><td>\$1.20</td></tr> </table>	1 PLU0030	\$32.80	1 PLU0031	\$13.00	1 PLU0031	\$13.00	TL	\$58.80	CASH	\$60.00	CG	\$1.20
1 PLU0030	\$32.80													
1 PLU0031	\$13.00													
1 PLU0031	\$13.00													
TL	\$58.80													
CASH	\$60.00													
CG	\$1.20													
2 Enter the unit price and press  key.	3 2 8 0 													
3 Enter the PLU number of the second item then press  key.	3 1 													
4 Enter the unit price.	1 3 00													
5 Press  key repeatedly for the number of purchased quantity and press  key.	  													
6 Enter the tendered amount and press  key.	6 0 00 													

To use the cash register's basic function

Other registrations

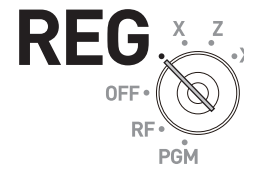

Discount

The following example shows how you can use the  key for discount registrations.



■ Discounts on items and subtotals



Sample Operation

Item 1	Dept. 01	\$5.00	Five percent (preset in  key) discount on PLU number 16 (preset unit price \$10.00) and discount 3.5% on the subtotal amount.
	Quantity	1	
	Taxable	1 (preset)	
Item 2	PLU 16	\$10.00 (preset)	
	Quantity	1	
	Taxable	2 (preset)	
Discount	Rate	5% (preset in )	
	Subtotal discount	Rate	
Subtotal discount	Taxable	Non taxable (preset)	
	Payment	Cash	

Step	Operation	Printout
1	Enter the unit price and corresponding department key.	<pre> 1 DEPT001 T1 \$5.00 1 PLU0016 T2 \$10.00 5% %- T2 -0.50 ST \$14.50 3.5% %- -0.51 TA1 \$5.00 TX1 \$0.20 TA2 \$9.50 TX2 \$0.48 TL \$14.67 CASH \$15.00 CG \$0.33 </pre>
2	Enter the PLU number then press key. The preset unit price (\$10.00) is registered.	
3	Press key. The discount amount with the preset rate (5%) is subtracted from the last item registered (PLU 16).	
4	Press key for giving discount on the subtotal amount.	
5	Enter the discount rate manually and press key. Discount amount with inputted rate is subtracted from the subtotal amount.	
6	Press key to show the total amount including tax and discounts.	
7	Enter the tendered amount and press key.	

Printout differs depending on preset tax statuses.

NOTE

- When you perform a discount operation on the last item registered, the tax of discount amount is calculated in accordance with the tax status programmed to the item.
- When you perform a discount operation on a subtotal amount, the tax of discount amount from subtotal is calculated in accordance with the tax status programmed in the  key.
- To program discount rate in  key, please see page E-26.

To use the cash register's basic function

Reduction

Using the reduction feature, you can subtract a certain amount from an item's unit price or from a subtotal amount.

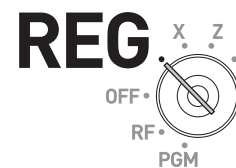

Sample Operation

Item 1	Dept. 01	\$5.00	<ul style="list-style-type: none"> • Reducing \$0.25 (manual input) from item 1 unit price. • Reducing \$0.50 (preset amount) from item 2. • Reducing \$0.75 (manual input) from subtotal amount.
	Quantity	1	
	Taxable	1 (preset)	
	Reduction	\$0.25	
Item 2	PLU 45	\$6.00 (preset)	
	Quantity	1	
	Taxable	1 (preset)	
	Reduction	\$0.50 (preset)	
Subtotal	Reduction	\$0.75	
	Taxable	Non taxable (preset)	
Payment	Cash	\$10.00	

Step	Operation	Printout
1 Register item 1 by inputting the unit price and department key.	5 0 0 <input type="button" value="1"/>	<pre> 1 DEPT001 T1 \$5.00 - T1 -0.25 1 PLU0045 T1 \$6.00 - T1 -0.50 - -0.75 TA1 \$10.25 TX1 \$0.41 TL \$9.91 CASH \$10.00 CG \$0.09 </pre>
2 Enter reduction amount manually and press <input type="button" value="-"/> key. \$0.25 is subtracted from the unit price.	2 5 <input type="button" value="-"/>	
3 Register item 2 by inputting the PLU number and <input type="button" value="PLU/S.DEPT"/> key.	4 5 <input type="button" value="PLU/S.DEPT"/>	
4 Press <input type="button" value="-"/> key. Pressing <input type="button" value="-"/> key without numeral entry subtracts the preset reduction amount (\$0.50 in this example) from the PLU's unit price.	<input type="button" value="-"/>	
5 Press <input type="button" value="SUB TOTAL"/> key for reducing amount from the subtotal.	<input type="button" value="SUB TOTAL"/>	
6 Enter reduction amount manually then press <input type="button" value="-"/> key. The inputted amount is subtracted from the subtotal amount.	7 5 <input type="button" value="-"/>	
7 Enter the tendered amount then press <input type="button" value="CA/AMT/TEND"/> key.	1 0 00 <input type="button" value="CA/AMT/TEND"/>	

Printout differs depending on preset tax statuses.

NOTE

- You can input up to seven digits reduction amount manually.
- To program preset reduction amount, please see page E-26.

To use the cash register's basic function

Registering various payment methods

Other than cash payments, you can register transactions made by checks, charges, credits, or even mixed tendering.

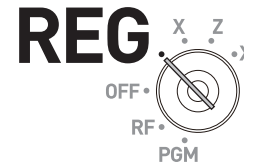

■ Check sale

Sample Operation

Item	Unit Price	\$11.00	A \$11.00 item is sold and customer paid by \$20.00 check (check number 1234).
	Quantity	1	
Reference no. of check		1234	
Payment	Check	\$20.00	

Step	Operation	Printout										
1 Register the item purchased.	1 1 00 <input type="button" value="1"/>	<table border="1"> <tr> <td>1 DEPT001</td> <td>\$11.00</td> </tr> <tr> <td>#</td> <td>1234</td> </tr> <tr> <td>TL</td> <td>\$ 11.00</td> </tr> <tr> <td>CHECK</td> <td>\$20.00</td> </tr> <tr> <td>CG</td> <td>\$9.00</td> </tr> </table>	1 DEPT001	\$11.00	#	1234	TL	\$ 11.00	CHECK	\$20.00	CG	\$9.00
1 DEPT001	\$11.00											
#	1234											
TL	\$ 11.00											
CHECK	\$20.00											
CG	\$9.00											
2 If you wish to record reference number such as a check number, enter the number then press <input type="button" value="#/NS"/> key.	1 2 3 4 <input type="button" value="#/NS"/>											
3 Enter the paid amount then press <input type="button" value="CHK"/> key.	2 0 00 <input type="button" value="CHK"/>											

■ Charge sale

Sample Operation

Item	Dept. 04	\$15.00	A purchased item is transacted by charge sale.
	Quantity	1	
Payment	Charge	\$15.00	

Step	Operation	Printout						
1 Register the item purchased and press <input type="button" value="SUB TOTAL"/> key.	1 5 00 <input type="button" value="4"/> <input type="button" value="SUB TOTAL"/>	<table border="1"> <tr> <td>1 DEPT004</td> <td>\$15.00</td> </tr> <tr> <td>TL</td> <td>\$ 15.00</td> </tr> <tr> <td>CHARGE</td> <td>\$15.00</td> </tr> </table>	1 DEPT004	\$15.00	TL	\$ 15.00	CHARGE	\$15.00
1 DEPT004	\$15.00							
TL	\$ 15.00							
CHARGE	\$15.00							
2 Press <input type="button" value="CH"/> key to finalize the charge transaction.	<input type="button" value="CH"/>							

To use the cash register's basic function

■ Credit sale

Sample Operation

Item	Dept. 03	\$10.00	A purchased item is paid by a credit card.
	Quantity	1	
Payment	Credit	\$10.00	

Step	Operation	Printout						
1 Register the item purchased and press <input type="button" value="SUB TOTAL"/> key.	1 0 00 <input type="button" value="3"/> <input type="button" value="SUB TOTAL"/>	<table border="1"> <tr> <td>1 DEPT003</td> <td>\$10.00</td> </tr> <tr> <td>TL</td> <td>\$10.00</td> </tr> <tr> <td>CREDIT</td> <td>\$10.00</td> </tr> </table>	1 DEPT003	\$10.00	TL	\$10.00	CREDIT	\$10.00
1 DEPT003	\$10.00							
TL	\$10.00							
CREDIT	\$10.00							
2 Press <input type="button" value="CR"/> key to finalize the transaction.	<input type="button" value="CR"/>							

■ Mixed payments (cash and check)

Sample Operation

Item	Dept. 04	\$55.00	Customer paid \$30.00 by check and the rest in cash for \$55.00 item.
	Quantity	1	
Payment	Check	\$30.00	
	Cash	\$25.00	

Step	Operation	Printout										
1 Register the item purchased and press <input type="button" value="SUB TOTAL"/> key.	5 5 00 <input type="button" value="4"/> <input type="button" value="SUB TOTAL"/>	<table border="1"> <tr> <td>1 DEPT004</td> <td>\$55.00</td> </tr> <tr> <td>TL</td> <td>\$55.00</td> </tr> <tr> <td>CHECK</td> <td>\$30.00</td> </tr> <tr> <td>CASH</td> <td>\$25.00</td> </tr> <tr> <td>CG</td> <td>\$0.00</td> </tr> </table>	1 DEPT004	\$55.00	TL	\$55.00	CHECK	\$30.00	CASH	\$25.00	CG	\$0.00
1 DEPT004	\$55.00											
TL	\$55.00											
CHECK	\$30.00											
CASH	\$25.00											
CG	\$0.00											
2 Enter the amount paid by a check then press <input type="button" value="CHK"/> key.	3 0 00 <input type="button" value="CHK"/>											
3 Enter the paid cash amount then press <input type="button" value="CA / AMT / TEND"/> key.	2 5 00 <input type="button" value="CA / AMT / TEND"/>											

To use the cash register's basic function

Tax shift

By using **T/S1** or **T/S2** keys, you can change the taxable status.

The **T/S1** key switches on and off of programmed taxable status 1 and **T/S2** key changes the taxable status 2. The following table explains how tax statuses change by **T/S1** or **T/S2** key.

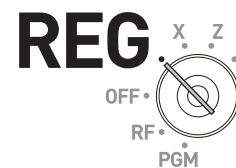

Non tax	T/S1	➔ Tax status 1	Non tax	T/S2	➔ Tax status 2
Tax status 1	T/S1	➔ Non-tax	Tax status 1	T/S1	➔ Tax status 1 & 2
Tax status 2	T/S1	➔ Tax status 1 & 2	Tax status 2	T/S1	➔ Non-tax

Sample Operation

Item 1	Dept. 01	\$2.00	<ul style="list-style-type: none"> Item 1 is shifted from non-taxable to tax status 1 by T/S1 key. Item 2 is shifted from tax status 1 to tax status 1 & 2 by T/S2 key. Item 3 is shifted from tax status 2 to non-taxable by T/S2 key. Preset tax rates : Tax 1 = 4% Tax 2 = 5%
	Quantity	1	
	Taxable	Non tax (preset) to tax status 1	
Item 2	Dept. 02	\$6.00	
	Quantity	1	
	Taxable	Tax status 1 (preset) to 1 & 2	
Item 3	Dept. 03	\$7.00	
	Quantity	1	
	Taxable	Tax status 2 (preset) to non-tax	
Payment	Cash	\$30.00	

Step

Operation

Printout

1 Press **T/S1** then register item 1. The tax status of the item 1 is changed from non-taxable to tax status 1.

T/S1 **2 00** **1**

2 Press **T/S2** then register item 2. The tax status of the item 2 is changed from tax status 1 to tax status 1 & 2.

T/S2 **6 00** **2**

3 Press **T/S2** then register item 3. The tax status of the item 3 is changed from tax status 2 to non-taxable.

T/S2 **7 00** **3**

4 Press **SUB TOTAL** key to indicate the total amount including tax.

SUB TOTAL

5 Enter tendered amount and press **CA / AMT / TEND** to finalize the transaction.

2 0 00 **CA / AMT / TEND**

1	DEPT001	T1	\$2.00
1	DEPT002	T12	\$6.00
1	DEPT003		\$7.00
	TA1		\$8.00
	TX1		\$0.32
	TA2		\$6.00
	TX2		\$0.30
	TL		\$ 15.62
	CASH		\$20.00
	CG		\$4.38

NOTE

- To change the tax status of the next item to be registered, be sure to press **T/S1**, **T/S2**.
- If the last item registered is programmed as non-taxable, a discount (**%-** key) operation on this item is always non-taxable. In this case, you cannot manually change the tax status to taxable 1 or 2 by pressing **T/S1**, **T/S2** keys.

To use the cash register's basic function

Registering returned goods

■ Registering returned goods in the REG mode

The following example shows how to operate for registering goods returned by customer in the REG mode.

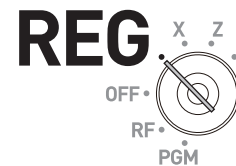

Sample Operation

Item 1	Dept. 01	\$2.35	Customer returned items 1 and 3 during the registration.
	Quantity	1	
Item 2	Dept. 02	\$2.00	
	Quantity	1	
Item 3	PLU 001	\$1.20 (preset)	
	Quantity	1	
Refunded Item 1	Dept. 01	\$2.35	
	Quantity	1	
Refunded Item 3	PLU 0001	\$1.20 (preset)	
	Quantity	1	
Payment	Cash	\$2.00	

Step	Operation	Printout
1 Register purchased item 1.	2 3 5 1	<pre> 1 DEPT001 \$2.35 1 DEPT002 \$2.00 1 PLU0001 \$1.20 RF 1 DEPT001 -2.35 RF 1 PLU0001 -1.20 TL \$2.00 CASH \$2.00 </pre>
2 Register purchased item 2.	2 00 2	
3 Register purchased item 3.	1 PLU/S.DEPT	
4 Press RF key prior to registering returned item 1.	RF	
5 Register returned item 1.	2 3 5 1	
6 Press RF key and register returned item 3. Then press SUB TOTAL key.	RF 1 PLU/S.DEPT SUB TOTAL	
7 Press CA/AMT/TEND key as the customer paid exact amount.	CA/AMT/TEND	

To use the cash register's basic function







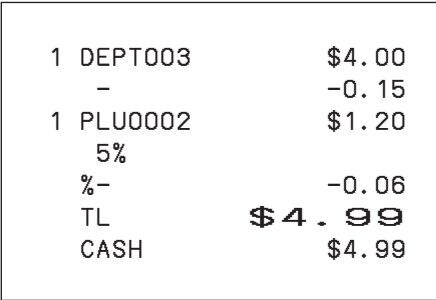

■ Registering returned goods in the RF mode

When a customer returns goods after the transaction has been completed, use RF mode for the refund operation.



Sample Operation

Refunded Item 1	Dept. 03	\$4.00	A customer returned two items. Item 1 was sold with \$0.15 reduction and item 2 was sold with pre-programmed 5% discount.
	Quantity	1	
	Reduced	\$0.15	
Refunded Item 2	PLU 002	\$1.20 (preset)	
	Quantity	1	
	Discounted	5% (preset)	
Payment	Cash	\$4.99	

Step	Operation	Printout
1	Turn the Mode switch to RF position.	
2	Register the returned items by the same operations as normal registration and press  key.	
	     	
3	Press  key and pay the total amount back to the customer.	

Important

- After the refund operation, please do not forget to return the Mode switch to REG position otherwise the following registrations are stored as minus transactions.

To use the cash register's basic function

Registrations without transactions

The followings are the operations other than normal sales transactions. Please do not perform these operations during a sales transaction.

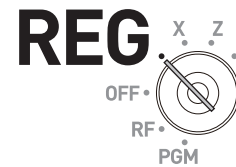

■ Registering money received on account

Use this operation when you put money in the drawer without any sales transactions such case as preparing change.

Sample Operation

Received amount	\$70.00	Prepared \$70.00 in the drawer for change before opening the store.
-----------------	---------	---

Step	Operation	Printout		
1 Enter the amount put in the drawer then press <input type="button" value="RA"/> key.	<input type="button" value="7"/> <input type="button" value="0"/> <input type="button" value="00"/> <input type="button" value="RA"/>	<table border="1"> <tr> <td>RA</td> <td>\$70.00</td> </tr> </table>	RA	\$70.00
RA	\$70.00			

■ Registering money paid out from the drawer.

Use this operation when you withdraw money from the drawer without any sales transactions such case as paying for a cash-on-delivery item.

Sample Operation

Paid out amount	\$1.50	Paying \$1.50 from the drawer.
-----------------	--------	--------------------------------

Step	Operation	Printout		
1 Enter the amount withdrawn from the drawer then press <input type="button" value="PO"/> key.	<input type="button" value="1"/> <input type="button" value="5"/> <input type="button" value="0"/> <input type="button" value="PO"/>	<table border="1"> <tr> <td>PO</td> <td>\$1.50</td> </tr> </table>	PO	\$1.50
PO	\$1.50			

■ Opening the drawer without putting money in or out

Use this operation to open the drawer without putting money in or out. The number of key operations will be printed on X or Z reports.

If you enter numbers prior to key, the number will be printed on the receipt or journal. (see page E-38)

Step	Operation	Printout		
1 Just press <input type="button" value="#/NS"/> key. The drawer opens.	<input type="button" value="#/NS"/>	<table border="1"> <tr> <td>#/NS</td> <td>.....</td> </tr> </table>	#/NS
#/NS			

To use the cash register's basic function

Corrections

There are three ways to correct erroneous operations that are;

- Correcting erroneous item not registered
- Correcting erroneous item already registered
- Cancelling all the items registered in a transaction

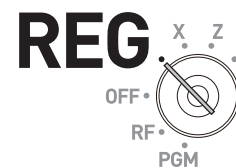

■ Correcting erroneously entered item not registered

Step	Operation	Printout														
1 Correcting wrong unit price \$2.00 to \$1.00.	2 00 <input type="button" value="C"/>	<div style="border: 1px solid black; padding: 5px;"> <table style="width: 100%; border-collapse: collapse;"> <tr> <td style="width: 60%;">1 DEPT001</td> <td style="text-align: right;">\$1.00</td> </tr> <tr> <td>11 DEPT002</td> <td style="text-align: right;">\$22.00</td> </tr> <tr> <td>1 PLU0003</td> <td style="text-align: right;">\$1.30</td> </tr> <tr> <td>1 PLU0015</td> <td style="text-align: right;">\$10.00</td> </tr> <tr> <td>TL</td> <td style="text-align: right;">\$34.30</td> </tr> <tr> <td>CASH</td> <td style="text-align: right;">\$15.00</td> </tr> <tr> <td>CHECK</td> <td style="text-align: right;">\$19.30</td> </tr> </table> </div>	1 DEPT001	\$1.00	11 DEPT002	\$22.00	1 PLU0003	\$1.30	1 PLU0015	\$10.00	TL	\$34.30	CASH	\$15.00	CHECK	\$19.30
1 DEPT001	\$1.00															
11 DEPT002	\$22.00															
1 PLU0003	\$1.30															
1 PLU0015	\$10.00															
TL	\$34.30															
CASH	\$15.00															
CHECK	\$19.30															
2 Correcting wrong quantity 12 to 11.	1 00 <input type="button" value="1"/> 1 2 <input checked="" type="button" value="X FOR DATE TIME"/> <input type="button" value="C"/>															
3 Correcting wrong PLU number 002 to 003.	1 1 <input checked="" type="button" value="X FOR DATE TIME"/> 2 00 <input type="button" value="2"/> <input type="button" value="C"/>															
4 Correcting open PLU unit price \$6.00 to \$10.00. You must re-enter the PLU number prior to entering correct unit price.	3 <input type="button" value="PLU/S.DEPT"/> 1 5 <input type="button" value="PLU/S.DEPT"/> 6 00 <input type="button" value="C"/>															
5 Correcting wrong partially tendered cash amount \$10.00 to \$15.00.	1 5 <input type="button" value="PLU/S.DEPT"/> 1 0 00 <input type="button" value="PRICE"/> <input type="button" value="C"/>															
6 The remaining amount is paid by check.	1 0 00 <input type="button" value="C"/> 1 5 00 <input type="button" value="CA / AMT / TEND"/> <input type="button" value="CH"/>															

To use the cash register's basic function

■ Correcting items immediately after the registration

Step	Operation	Printout
1 Registering an item.	1 00 1	
2 By mistake, Dept. key has been pressed twice so cancelling the preceding registration by ERR CORR CANCEL key.	2 00 2 2 ERR CORR CANCEL	
3 Cancelling wrong PLU registration (PLU No. 2) and re-registering correct PLU (PLU No. 5).	2 PLU/ S.DEPT ERR CORR CANCEL 5 PLU/ S.DEPT	
4 Cancelling a registration of an open PLU's (PLU No. 15) wrong unit price \$6.00 and re-registering the item with the correct unit price \$10.00.	1 5 PLU/ S.DEPT 6 00 PRICE ERR CORR CANCEL 1 5 PLU/ S.DEPT 1 0 00 PRICE	
5 Cancelling a registration of an item with wrong quantity (8 pieces) and re-registering the item with the correct quantity (6 pieces).	8 X / FOR DATE TIME 4 00 4 ERR CORR CANCEL 6 X / FOR DATE TIME 4 00 4	
6 The remaining amount is paid by check. Cancelling wrong subtotal discount calculation (with rate of 50%) and re-calculating the discount amount with the correct rate (5%).	SUB TOTAL 5 0 %- ERR CORR CANCEL SUB TOTAL 5 %-	
7 Cancelling wrong refund amount (\$2.00) and re-registering correct amount (\$2.20).	RF 2 00 2 ERR CORR CANCEL RF 2 2 0 2	
8 Getting the subtotal amount.	SUB TOTAL	
9 Cancelling partially tendered cash amount (\$20.00) and re-registering correct amount (\$15.00).	2 0 00 CA / AMT TEND ERR CORR CANCEL 1 5 00 CA / AMT TEND	
10 The customer paid the balance due by check.	CHK	

1	DEPT001	\$1.00
1	DEPT002	\$2.00
1	DEPT002	\$2.00
	CORR	-2.00
1	PLU0002	\$2.00
	CORR	-2.00
1	PLU0005	\$1.50
1	PLU0015	\$6.00
	CORR	-6.00
1	PLU0015	\$10.00
8	DEPT004	\$32.00
	CORR	-32.00
6	DEPT004	\$24.00
	ST	\$38.50
	50%	
	%-	-19.25
	CORR	\$19.25
	ST	\$38.50
	5%	
	%-	-1.93
	RF
1	DEPT	-2.00
	CORR	\$2.00
	RF
1	DEPT002	-2.20
	TL	\$34.37
	CASH	\$20.00
	CORR	-20.00
	CASH	\$15.00
	CHECK	\$19.37



Corrected items are not printed on receipt if programmed as "Buffered receipt printing".

To use the cash register's basic function

■ Voiding an item which has been already registered

Step

1 During a registration.

2 Using  or  keys, select the item you have mis-registered.

3 Press  key. The selected item is voided.

Display



CLERK001	REG	000011
3	DEPT001	\$6.00
1	PLU002	\$2.00
3	DEPT002	\$9.00
2	PLU003	\$4.00
1	DEPT003	\$2.00
SUBTOTAL		\$24.00
QT	11	0.00

[REVIEW / VOID]		
1	PLU001	\$1.00
3	DEPT001	\$6.00
1	PLU002	\$2.00
3	DEPT002	\$9.00
2	PLU003	\$4.00
1	DEPT003	\$2.00
VOID :<CA AMT/TEND>		
CANCEL:<SUB TOTAL>		
		0.00

CLERK001	REG	000011
2	PLU003	\$4.00
1	DEPT003	\$2.00
1	DEPT003	\$2.00
SUBTOTAL		\$22.00
QT	10	0.00

■ Cancelling all items in a transaction

Step

1 Press  key after items have been registered then press  key.

2 Select [YES] on the pop up display.

3 Press  key. The registered items are cancelled.

Display

CLERK001	REG	000011
3	DEPT001	\$6.00
1	PLU002	\$2.00
3	DEPT002	\$9.00
2	PLU003	\$4.00
1	DEPT003	\$2.00
SUBTOTAL		\$24.00
QT	11	0.00

CLERK001	REG	000011
CANCEL OPERATION		
Please select		
Yes	:<CA/AMT TEND>	
No	:<C>	
ST		\$24.00
QT	11	0.00

CLERK001	REG	000011
1	PLU002	\$2.00
3	DEPT002	\$9.00
2	PLU003	\$4.00
1	DEPT003	\$2.00
CANCEL	
SUBTOTAL		\$0.00
CANCEL		0.00

To use the cash register's basic function

Daily sales reports

At the end of the business day, you can print categorized and summarized results of the day. Reset report (Z) clears all the sales data whereas the data remains in memory by Read report (X).

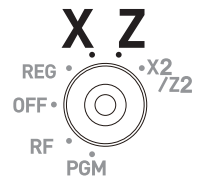



NOTE Please do not perform the Reset report (Z) printing while your store is open. It clears all the sales data.

Step

Display

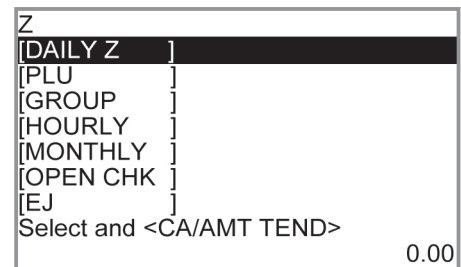
1 Turn the Mode switch to X or Z position. The display shows top display of sales reports.



2 Select [DAILY Z] (DAILY X when you set the Mode switch to X) and press  key. The printer issues a sales report.

Further operations:

- For individual reports, please see page E-89.

To use the cash register's basic function

Print out of daily sales report

Z	20-06-2013	17:00	1
	0001	000231	2

Z	DAILY Z		3

Z	DEPT	0001	4
		0001015	5
DEPT001		203.25	
		\$1,108.54	6
DEPT002		183	
		\$1,362.26	
		5	
		\$47.00	

TL		421.25	7
		\$2,872.28	

Z	FIX	0001	8
		0001011	9
GROSS		981.25	
		\$6,574.40	10
NET	No 111		
		\$7,057.14	11
CAID		\$1,919.04	12
CHID		\$139.04	13
CKID		\$859.85	14
CRID(1)		\$709.85	15
CRID(2)		\$0.00	16
CRID(3)		\$0.00	17
CRID(4)		\$0.00	18

RF	No	3	19
		\$10.22	
CUST	CT	111	20
AVRG		\$63.57	21
DC		\$1.22	22
REF		\$2.42	23
ROUND		\$0.00	24
CANCEL	No	2	25
		\$12.97	

- 1 Date/time
- 2 Machine No./consecutive No.
- 3 Report title
- 4 Department report title/reset counter
- 5 Report code
- 6 Department count/amount *1
- 7 Department total count/total amount
- 8 Fixed total report title/reset counter
- 9 Report code
- 10 Gross total *2
- 11 Net total *2
- 12 Cash in drawer *2
- 13 Charge in drawer *2
- 14 Check in drawer *2
- 15 Credit in drawer 1 *2
- 16 Credit in drawer 2 *2
- 17 Credit in drawer 3 *2
- 18 Credit in drawer 4 *2
- 19 Refund mode *2
- 20 Number of customer *2
- 21 Average sales per customer *2
- 22 Discount total *2
- 23 Refund key *2
- 24 Rounding total *2
- 25 Cancellation

* 1 If total amount is zero, these items will not be printed.

* 2 These items can be skipped by programming.

To use the cash register's basic function

TA1		\$2,369.69	26
TX1		\$128.86	27
TA2		\$2,172.96	28
TX2		\$217.33	29

GT	\$00000000	125478.96	30

Z	TRANS	0001	31
		0001012	32
CASH	No	362	33
		\$1,638.04	
CHARGE	No	56	
		\$1,174.85	
RA	No	4	
		\$810.00	
P0	No	5	
		\$520.00	
		\$5.00	
CORR	No	14	
		\$39.55	
RCT	No	3	
NS	No	5	

- 26 Taxable 1 amount *²
- 27 Tax 1 amount *²
- 28 Taxable 2 amount *²
- 29 Tax 2 amount *²
- 30 Grand total *²
- 31 Function key report title/reset counter
- 32 Report code
- 33 Function key count/amount *¹

* 1 If total amount is zero, these items will not be printed.

* 2 These items can be skipped by programming.

Advanced programmings and registrations

Advanced registrations.....	E-51
Enabling clerk assignment.....	E-51
Registrations with clerk assignment.....	E-52
Single item cash sales	E-53
Character settings.....	E-55
Using character keyboard.....	E-55
Using ten key pad	E-56
Setting characters	E-58
Setting pop messages on receipts.....	E-59
Setting symbol characters	E-61
Advanced programmings	E-64
Programming detail settings.....	E-65
Programming functions of departments and PLUs in a lump	E-73
Programming department functions in a lump	E-73
Programming PLU functions in a lump	E-75
Programming functions of departments and PLUs individually	E-76
Programming functions of departments individually.....	E-76
Programming functions of PLUs individually.....	E-78
Programming functions of transaction keys	E-79
Programming further clerk functions.....	E-83
Printing programmed data	E-84
To print programmed unit price or percentage (other than PLU).....	E-84
To print programmed characters (except PLUs)	E-85
To print general programming (except PLUs).....	E-86
To print preset unit price of PLU	E-87
To print preset characters of PLU.....	E-88
To print PLU programmings	E-88
Printing various sales reports.....	E-89
Printing various sales reports.....	E-89
Periodic sales report.....	E-93
Using an SD card.....	E-96
To format an SD card.....	E-96
To store program data in an SD card.....	E-97
Before you consider it as a problem	E-99
Error code table	E-99
When “EJ FULL” sign appears on the display.....	E-101
In case of power failure.....	E-101
In case the register is locked up.....	E-101
About the low battery indicator	E-102
Specifications	E-103

Advanced registrations

Enabling clerk assignment

By assigning a clerk, clerk number or name will be printed on receipts. The following operation enables the register to use the clerk assignment.

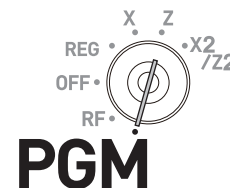

Step	Operation
1	Turn the Mode switch to PGM position. The display shows programming top menu.
2	Using and keys, select [System Setting] and press key. [System Setting] is the last column on the programming top menu and is not shown on the first screen. Keep pressing key until it appears on the screen.
3	Enter from ten key pad then press key. This operation sets the register in program mode.
4	Enter from ten key pad and press key. Number 2722 is the program code for clerk assignment setting.
5	Enter and eight zeros from the ten key pad then press key. Number 40000000 is the set code to enable clerk assignment.
	If you wish to disable the clerk assignment feature later on, perform these steps and enter nine zeros in this step.
6	Press key to complete the setting.

NOTE

You can also program fro enabling clerk operations by detail setting program. Please see page E-72 "Set code 27".

Advanced programmings and registrations

Registrations with clerk assignment

By signing a clerk on, the clerk name will be printed on receipts and sales reports.

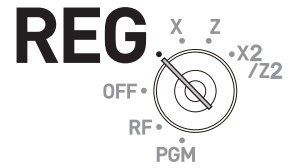

Step	Operation	Printout
1 Enter the clerk number and press <input type="button" value="CLK#"/> key.	1 <input type="button" value="CLK#"/>	<pre>* commercial message * REG 20-06-2013 11:58 C01 0001 000123 1 1 DEPT01 T1 \$1.00</pre>
2 Perform registration operations. The clerk name is printed on receipts and displayed on top of the display.		
3 To sign a clerk off, enter 0 and 0 <input type="button" value="CLK#"/> press <input type="button" value="CLK#"/> key. Or just press <input type="button" value="SIGN OFF"/> key.	0 <input type="button" value="CLK#"/>	

1: Clerk Name/Machine No./Consecutive No.

NOTE The clerk number is cleared when the Mode switch is turned to OFF position.

Further operation:

You can sign on the register by clerk's secret number instead of clerk number. Also you can set characters for clerks' names. To set clerks' secret numbers and names, see page E-26.

Advanced programmings and registrations

Single item cash sales

A department key or a PLU programmed as single item sale status finalizes the transaction as soon as it is registered. This feature can be used only in cash sales. To program single item sales status see pages E-76 and E-77.

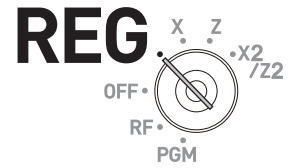



Sample operation 1: Simple single item sale

Item	Dept. 01	\$1.00	Dept. 01 is programmed as single item sale and unit price is not preset.
	Quantity	1	
	Preset	Single item	
Payment	Cash	\$1.00	

Step	Operation	Printout
1 Enter the unit price then press corresponding department key. The transaction is finalized immediately after the department key depression..	1 00 1	<pre> 1 DEPT001 \$1.00 TL \$1.00 CASH \$1.00 </pre>

Sample operation 2: Single item sale with multiplication

Item	Dept. 01	\$1.00	Selling three pieces of items of dept. 01 in which unit price \$1.00 and single item sale status is pre-programmed.
	Quantity	3	
	Preset	Single item	
Payment	Cash	\$3.00	

Step	Operation	Printout
1 Enter the quantity and press  key for multiplication.	3 	<pre> 3 DEPT001 \$3.00 TL \$3.00 CASH \$3.00 </pre>
2 Press corresponding department key. The transaction is finalized immediately.	1	

Useful features

Advanced programmings and registrations

Sample operation 3: Single item sale with another item

Item 1	Dept. 03	\$2.00	Dept. 03 is a normal department while dept. 01 is programmed as unit price \$1.00 and single item sale status.
	Quantity	1	
	Preset	Normal	
Item 2	Dept. 01	\$1.00	
	Quantity	1	
	Preset	Single item	
Payment	Cash	\$3.00	

Step	Operation	Printout								
1 Register item 1.	2 00 3	<table border="1"> <tr> <td>1 DEPT003</td> <td>\$2.00</td> </tr> <tr> <td>1 DEPT001</td> <td>\$1.00</td> </tr> <tr> <td>TL</td> <td>\$3.00</td> </tr> <tr> <td>CASH</td> <td>\$3.00</td> </tr> </table>	1 DEPT003	\$2.00	1 DEPT001	\$1.00	TL	\$3.00	CASH	\$3.00
1 DEPT003	\$2.00									
1 DEPT001	\$1.00									
TL	\$3.00									
CASH	\$3.00									
2 Single item sale department key does not finalize the transaction as it is not single item sale.	1									
3 Press <input type="button" value="CA/AMT/TEND"/> key to finalize the transaction.	<input type="button" value="CA/AMT/TEND"/>									

Character settings

This chapter explains how you can program department or PLU descriptions, store messages, key descriptions, report title, total descriptions (such as gross total, net total etc.) and clerk names.

There are two ways to program characters which are using character keyboard and using multi typing of ten key.

Using character keyboard

■ Character keyboard

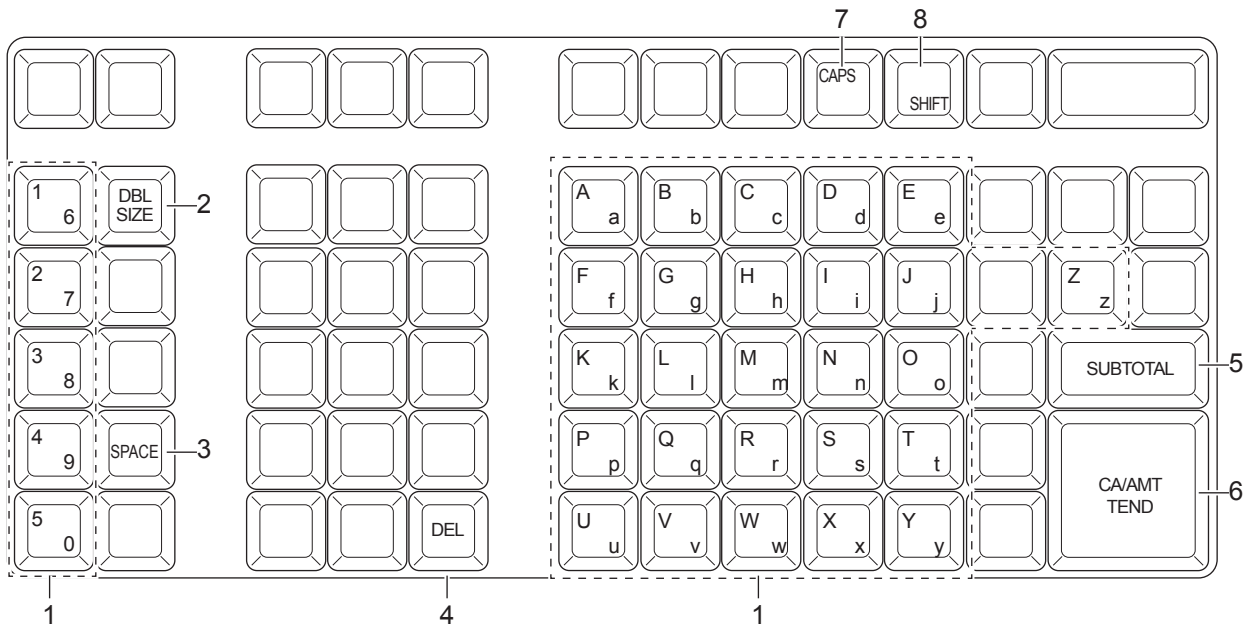

- | | |
|--|---|
| <p>1 Alphabet keys</p> <p>2 Double size letter key</p> <p>3 Space key</p> <p>4 Delete key</p> <p>5 Program end key</p> <p>6 Character enter key</p> <p>7 CAPS key</p> <p>8 Shift key</p> | <p>Used to input characters.</p> <p>Assigns the next input character to be double sized. After setting a double sized character, press this key again to back to normal size.</p> <p>Sets a space.</p> <p>Clears the last input character.</p> <p>Terminates the character programming.</p> <p>Registers the programmed characters.</p> <p>Pressing this key shifts a character from the lowercase letter to upper case letter.</p> <p>Pressing this key shifts the character from the uppercase letter to lower case letter.</p> |
|--|---|

Example: To set "Apple Juice"

A **p p l e** **J** **u i c e**

<DBL> <A> <DBL> <Shift> <p> <p> <l> <e> <Space> <CAPS> <J> <Shift> <u> <i> <c> <e> .

Advanced programmings and registrations

Using ten key pad

To set characters by using ten key, you need to press one of the ten key repeatedly until desired character appears on the display.

■ Multi typing keyboard

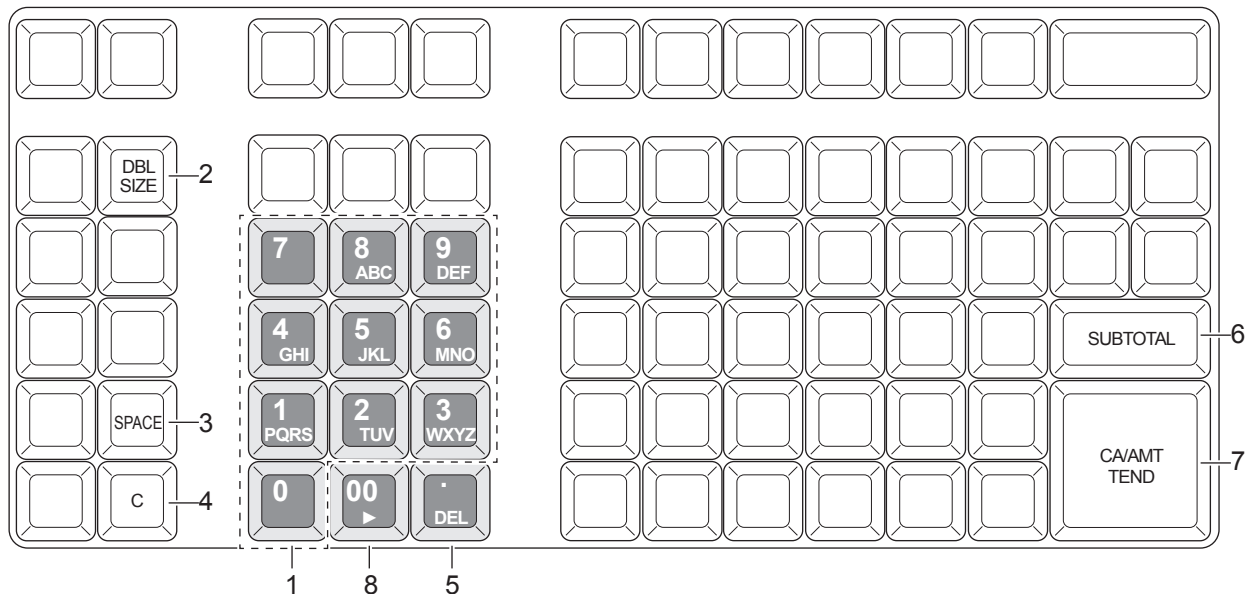

1 Alphabet keys

Hitting one of those keys repeatedly changes characters in the order shown in the table below.

8	A → B → C → a → b → c → 8 → Ä → Å → Æ → Á → Â → Æ → Ç → â → ä → à → á → æ → á → ä → ç returns to the beginning
9	D → E → F → d → e → f → 9 → ð → É → Ê → Ë → È → ð → é → ê → ë → è → f returns to the beginning
4	G → H → I → g → h → i → 4 → Í → Î → Ï → I → Ì → Î → Î → Í → í → i returns to the beginning
5	J → K → L → j → k → l → 5 returns to the beginning
6	M → N → O → m → n → o → 6 → Ñ → Ö → ø → Ó → Ô → Ò → Õ → ñ → ô → ö → ò → ø → ó → õ returns to the beginning
1	P → Q → R → S → p → q → r → s → 1 → p → p → ß returns to the beginning
2	T → U → V → t → u → v → 2 → TEL → Ü → Ú → Û → Ü → ü → û → ù → ú → μ returns to the beginning
3	W → X → Y → Z → w → x → y → z → 3 → ŷ → Ÿ → ŷ returns to the beginning
0	0
00	(Right cursor)
.	(Delete)
7	7 → @ → - → / → : → ! → ? → ~ → (→) → * → # → + → , → ^ → ; → < → → = → > → \$ → ¥ → % & → [→] → ' → { → → } → • → “ → . → \ → _ → ` → £ → x → ù → i → € → \$ → space returns to the beginning

Advanced programmings and registrations



- 2 **Double size letter key** Assigns the next input character to be double sized. After setting a double sized character, press this key again for normal size.
- 3 **Space key** Sets a space.
- 4 **Clear key** Clears all the characters.
- 5 **Delete key** Clears the last input character.
- 6 **Program end key** Terminates the character programming.
- 7 **Character enter key** Registers the programmed characters.
- 8 **Right cursor key** Moves the cursor to the right.

Example: To set **C**LASS a

C **L** **A** **S** **S** **a**
<DBL> 8 8 8 5 5 5 <DBL> 8 1 1 1 1 00 1 1 1 1 <Space> 8 8 8 8

Advanced programmings and registrations

Setting characters

The following explanation shows how you can set a name in a PLU. You can also set names to departments, function keys (, ), and clerks by the same method.

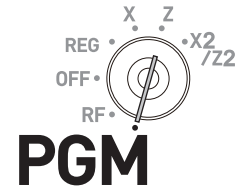

Sample Operation



To set "MILK" to PLU0001 by using ten key pad.

Step

1 Turn the Mode switch to PGM position. The display shows the program top menu.

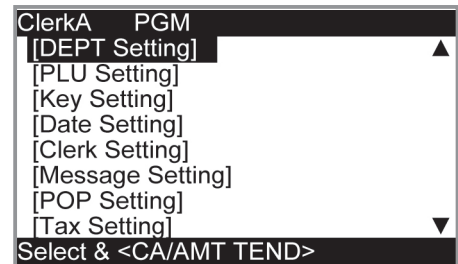

Display

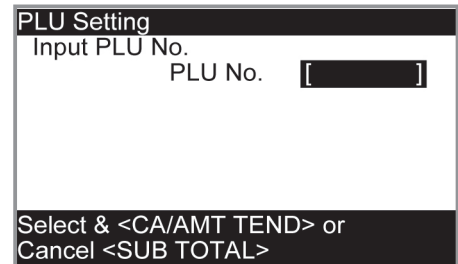

2 Using  or  keys, select [PLU Setting] and press  key.



Enter the PLU number in which you wish to set characters and press  key.

3 On the next screen, make sure that the PLU number you wish to set is selected. If you wish to change it, use  or  keys.

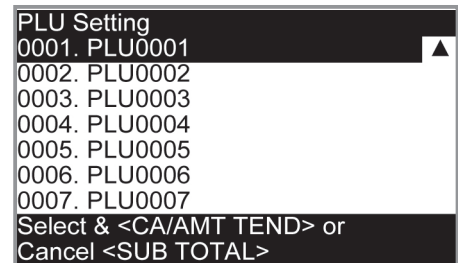

Press  key.

4 Select the top column of the [PLU Setting screen] and input the character you wish to set. In this example, **6 4 4 4 5 5 5 00 5 5** (for MILK). Then press  key to complete the setting.

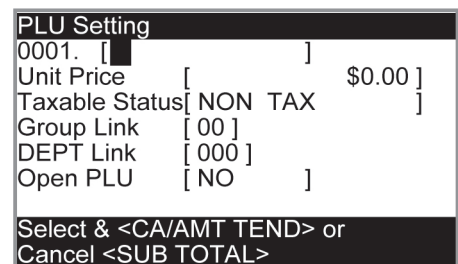

Advanced programmings and registrations

Setting pop messages on receipts

You can set pop messages printed on receipts.





- 1 Pop message 1st. line
- 2 Pop message 2nd. line
- 3 Pop message 3rd. line
- 4 Pop message 4th. line
- 5 Pop illustration

■ To set pop message

Step

1 Turn the Mode switch to PGM position and select [POP Setting] then press  key.

2 Select [All Message] and press  key. Preset messages will be printed.

3 Select the line number of the pop message and press  key.

4 Referring printed preset messages, input the message number you wish to set and press  key.

5 Repeat the steps 3 and 4 for other message lines.

■ To set other messages

To set logo message, commercial message, and bottom message (refer to page E-19 "Receipt sample"), perform the same procedure as the above operations except selecting [Message Setting] in step 1.

Display

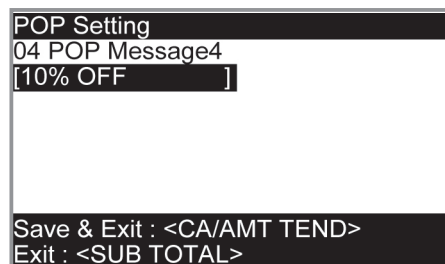
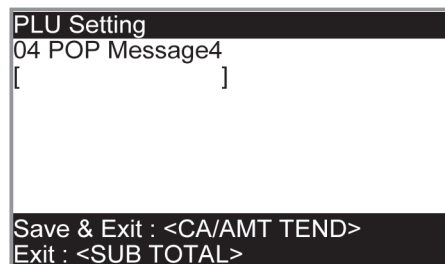
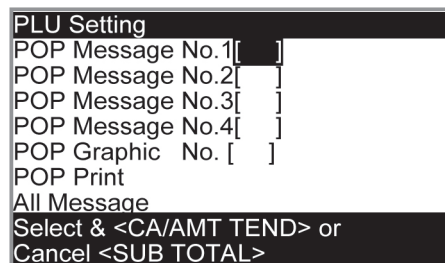

Advanced programmings and registrations

■ To set pop illustration

Step

1 Turn the Mode switch to PGM position and select [POP Setting] then press  key.

2 Select [All Graphic] and press  key. The printer prints preset pop illustrations.

3 From the printout, select an illustration you wish to print on receipts.

4 Select [Print Graphic No. []] and input the illustration number from ten key pad. Then press  key.

4 Select [POP Print] and press  key. Make sure that the illustration you select comes out from the printer.

Display

```
PLU Setting
POP Message No.1[ ]
POP Message No.2[ ]
POP Message No.3[ ]
POP Message No.4[ ]
POP Graphic No. [ ]
POP Print
All Message
Select & <CA/AMT TEND> or
Cancel <SUB TOTAL>
```

```
POP Setting
POP Message No.2 [ ]
POP Message No.3 [ ]
POP Message No.4 [ ]
POP Graphic No. [ ]
POP Print
All Message
All Graphic
Select & <CA/AMT TEND> or
Cancel <SUB TOTAL>
```

```
POP Setting
POP Message No.1[ ]
POP Message No.2[ ]
POP Message No.3[ ]
POP Message No.4[ ]
POP Graphic No.[ ]
POP Print
All Message
Select & <CA/AMT TEND> or
Cancel <SUB TOTAL>
```

```
POP Setting
POP Message No.1[ ]
POP Message No.2[ ]
POP Message No.3[ ]
POP Message No.4[ ]
POP Graphic No. [ ]
POP Print
All Message
Select & <CA/AMT TEND> or
Cancel <SUB TOTAL>
```

Advanced programmings and registrations

Setting symbol characters

You can change the symbols or titles of sales reports for example, printing “CASH IN DRW” on the sales reports instead of “CAID” for cash amount in drawer.

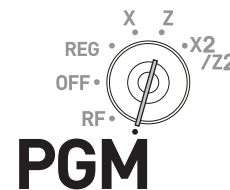

Step	Operation						
<p>1 Turn the Mode switch to PGM position and select [System Setting] then press key.</p> <p>[System Setting] is the last column on the programming top menu and is not shown on the first screen. Keep pressing key until it appears on the screen.</p>						
<p>2 Enter 2 and press key to set the register in the character setting mode.</p>							
<p>3 Referring the following tables, enter two-digit memory number and program code. Then press key.</p>	<table border="1"> <tr> <td><input type="text"/></td> <td><input type="text"/></td> <td><input type="text"/></td> <td><input type="text"/></td> <td></td> </tr> </table> <p>[Memory No.](Program code)</p>	<input type="text"/>	<input type="text"/>	<input type="text"/>	<input type="text"/>		
<input type="text"/>	<input type="text"/>	<input type="text"/>	<input type="text"/>				
<p>4 Referring the character entry methods on pages E-55 and E-56, input characters you wish to set and press key.</p>	<table border="1"> <tr> <td><input type="text"/></td> <td><input type="text"/></td> <td>.....</td> <td><input type="text"/></td> <td><input type="text"/></td> <td></td> </tr> </table> <p>(Character keys)</p>	<input type="text"/>	<input type="text"/>	<input type="text"/>	<input type="text"/>	
<input type="text"/>	<input type="text"/>	<input type="text"/>	<input type="text"/>			
<p>5 If you wish to set in the next memory number, repeat step 4. If you wish to set other memory number than the next number, repeat steps 3 and 4.</p>							
<p>6 Press key to complete the setting.</p>							

Example: To set “CASH IN DRW” in memory number 3

Press **0 3 0 1** [C][A][S][H][SPACE][I][N][SPACE][D][R][W]

Advanced programmings and registrations

Other symbols

Numbers in () are digits to be used.

Memory No.	Program code	Contents	Default character
01	23	main currency symbol (2), @ (2), No.(2), split pricing (2), not used (4), sub currency symbol (2)	· @ N o / * *
02		No. of item sold (2), No. of customers (2), not used (6), multiplication display(2)	N o C T @ L B * Q T
03		multiplication symbol (6), not used (6)	X B U S Y
04		taxable symbols (3 each)	T 1 T 1 T 3 T 4 T 5
06		taxable symbols (3 each)	T 1 2 T 1 3 T 1 4 T 2 3
08		foreign currency (2 each) not used (8)	* * * * *
09		mode symbols (4 each) (REG, RF, not used)	R E G R F R
10		mode symbols (4 each) (PGM, Daily X, Daily Z, Periodic)	P X Z X Z
11		mode symbols (4 each) (not used, PGM read)	T R G P G M X
12		decimal (1) (for amount/ q'ty), separator (main/ sub 1 each), not used (3), square (7)	· · · · · , X
13		am, pm (3each) ST symbol on main display (2)	A M P M S T
16		subtotal symbol on main display (16)	S T
17		subtotal symbol for discount/premium (16)	S T
18		post receipt total symbol (16)	T L
19		change symbol (16)	C G
01		20	grand total symbol (16)

Title of sales reports

Memory No.	Program code	Contents	Default character	Memo for your settings
01	24	Fixed total report title	FIX	
02		Transaction key report title	TRANS	
03		PLU sales report title	PLU	
04		Department sales report title	DEPT	
05		Group sales report title	GROUP	
06		Clerk sales report title	CASHIER	
08		Hourly sales report title	HOURLY	
09		Monthly sales report title	MONTHLY	
16		Flash report title	FLASH	

Advanced programmings and registrations

Advanced programmings

This section explains how you can program detail settings of the register such as setting register's specific number, whether to reset consecutive number on the receipt after a Reset (Z) report or not, whether to print taxable amounts on receipts or not, etc.

The following table lists what can be programmed in this settings.

Set code	Settings	No. of digit to be set
02	Cash register's unit number	4
03	Whether to reset consecutive number after Reset (Z) report or not	8
04	Tax system (USA or Canada)	9
05	Contents of receipt/journal print	10
06	Calculation and operation methods	10
08	Contents of sales reports	10
10	Whether to print taxable amount or not	10
14	Printing of period or comma for decimal and separator on fixed total report print	8
15	Printing methods of sales reports	10
16	Printing methods of grand total	7
17	Date/time printing on journals/receipts	4
19	Double height character printing on receipts	7
21	Printing methods of messages	10
27	Clerk operation selections	9
30	Receipt message/Compressed journal print selection	5
34	Backlight on/off selection	4

Advanced programmings and registrations

Programming detail settings

To program the detail settings of the register, please follow the operations shown below.

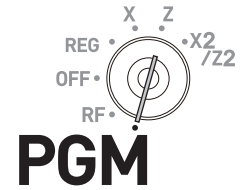

Step	Operation
------	-----------

1 Turn the Mode switch to PGM position and select [System Setting] then press key.



[System Setting] is the last column on the programming top menu and is not shown on the first screen. Keep pressing key until it appears on the screen.

2 Enter and press key to set the register in the programming mode.



3 Referring the following tables, enter two-digit set code you wish to program followed by two 2s. "22" is the identification code for programming detail settings.



[set code]

For example, if you wish to program tax system:



4 Referring the tables below, enter program code of up to 10 digits and press key.



[Program code (up to 10 digits)]

5 Press key to complete the program.



Useful features

Set code 02 (Machine number)

Description	Selection	Program code	Default value
Machine number	Machine number	<input type="text"/> <input type="text"/> <input type="text"/> <input type="text"/> D4 D3 D2 D1	<input type="text" value="0"/> <input type="text" value="0"/> <input type="text" value="0"/> <input type="text" value="0"/> D4 D3 D2 D1

Example: To set the register's specific unit number 1234.

Press

Set code 03 (Whether to reset consecutive number after Reset (Z) report or not)

Description	Selection	Program code	Default value
Reset consecutive number after daily reset report is issued.	Yes = 0 No = 1	<input type="checkbox"/> D8	<input type="text" value="0"/> D8
Must be "0000000" (seven zeros)		<input type="checkbox"/> to <input type="checkbox"/> D7 to D1	<input type="text" value="0"/> to <input type="text" value="0"/> D7 to D1

Example: Not resetting the consecutive number after Z report printing.

Press

Advanced programmings and registrations

Set code 04 (Tax system)

Description	Selection	Program code	Default value
Canadian rounding system Roundings Last digit: 0 to 2 → 0, 3 to 7 → 5, 8 and 9 → 10	No = 0 Yes = 7	<input type="checkbox"/> D10	<input type="checkbox"/> D10
US tax system = 1, Canadian tax system = 2 (Default value depends on the country shipped to)	Select 0 or 1	<input type="checkbox"/> D9	<input type="checkbox"/> 1 or <input type="checkbox"/> 2 D9
Must be "00000000" (eight zeros)		<input type="checkbox"/> 0 to <input type="checkbox"/> 0 D8 to D1	<input type="checkbox"/> 0 to <input type="checkbox"/> 0 D8 to D1

Example: To set Canadian tax system with canadian rounding system.

Press **3** **0 4 2 2** **7 2 0 0 0 0 0 0 0 0 0 0**

Set code 05 (Receipt printing selections)

Description	Selection	Program code	Default value
Print total line during finalization.	a Yes = 0 No = 1	<input type="checkbox"/>	<input type="checkbox"/>
24- hour system (0) or 12 -hour system (2)	b Select 0 or 2	(a+b) D10	(a+b) D10
Buffered receipt print (enables key operations during printing)	No = 0 Yes = 2	<input type="checkbox"/> D9	<input type="checkbox"/> D9
Skip item prints on journal. (journal skip)	No = 0 Yes = 1	<input type="checkbox"/> D8	<input type="checkbox"/> D8
Must be "000"		<input type="checkbox"/> 0 <input type="checkbox"/> 0 <input type="checkbox"/> 0 D7 D6 D5	<input type="checkbox"/> 0 <input type="checkbox"/> 0 <input type="checkbox"/> 0 D7 D6 D5
Print number of item sold. (item counter)	a No = 0 Yes = 1	<input type="checkbox"/>	<input type="checkbox"/>
Print tax symbols.	b Yes = 0 No = 2	(a+b) D4	(a+b) D4
Must be "000"		<input type="checkbox"/> 0 <input type="checkbox"/> 0 <input type="checkbox"/> 0 D3 D2 D1	<input type="checkbox"/> 0 <input type="checkbox"/> 0 <input type="checkbox"/> 0 D3 D2 D1

Example:

- On a receipt, not printing total amount (a = 1), printing 12 -hour system (b = 2): D10 = 3 (1 + 2).
- Buffered receipt printing: D9 = 2.
- Not printing items on journal (journal skip): D8 = 1.
- D7 – D5 must be 000.
- Printing number of items (a = 1), not printing tax symbols (b = 2): D4 = 3 (1 + 2).
- D3 – D1 must be 000.

Press **3** **0 5 2 2** **3 2 1 0 0 0 0 3 0 0 0**

Advanced programmings and registrations

Set code 06 (Calculation and operation methods)

Description	Selection	Program code	Default value
Succeeds the taxable status and commission status of previous item when +/- operation is performed.	a Yes = 0 No = 1	<input type="checkbox"/> (a+b) D10	<input type="checkbox"/> (a+b) D10
Force money declarations before read(X) or reset (Z) reports operations.	b No = 0 Yes = 4		
Force to press <input type="button" value="SUB TOTAL"/> key before finalization.	a No = 0 Yes = 1		
Allow finalization when subtotal amount is zero or minus.	b Yes = 0 No = 2	<input type="checkbox"/> (a+b+c) D9	<input type="checkbox"/> (a+b+c) D9
Allow multiple refund operation.	c Yes = 0 No = 4		
Affects the results of +/-, %+/%- calculations to items. (Net totaling)	No = 0 Yes = 1	<input type="checkbox"/> D8	<input type="checkbox"/> D8
Include commission in net total.	Yes = 0 No = 2	<input type="checkbox"/> D7	<input type="checkbox"/> D7
Clears the key buffer when a receipt is issued. (REG mode only)	a No = 0 Yes = 1		
Sounds key catch tone.	b Yes = 0 No = 2	<input type="checkbox"/> (a+b+c) D6	<input type="checkbox"/> (a+b+c) D6
Allow to issue post receipt, even the original one is issued.	c No = 0 Yes = 4		
Must be "000"		<input type="checkbox"/> <input type="checkbox"/> <input type="checkbox"/> D5 D4 D3	<input type="checkbox"/> <input type="checkbox"/> <input type="checkbox"/> D5 D4 D3
Use <00> key as <000> key.	<00> = 0 <000> = 4	<input type="checkbox"/> D2	<input type="checkbox"/> D2
Must be "0"		<input type="checkbox"/> D1	<input type="checkbox"/> D1

Example:

- A +/- operation not succeeds taxable status and commission status (a = 1), amount in drawer should be declared before Z reporting (b = 4): D10 = 5 (1 + 4).
- key must always be pressed for a finalization (a = 1), not allowing zero or minus subtotal in a transaction (b = 2), not allowing multiple refund operations (c = 4): D9 = 7 (1 + 2 + 3).
- Affecting the result of +/-, %+/%- to an item: D8 = 1.
- Not including commission in net total: D7 = 2.
- Clearing key buffer when a receipt is issued (a = 1), not sounding key catch tone (b = 2), issues post receipts even the original receipt is issued (c = 4): D6 = 7 (1 + 2 + 3).
- D5 – D3 must be 000.
- Using 00 key as 000 key D2 = 4.
- D1 must be 0.

Press

Advanced programmings and registrations

Set code 08 (Fixed total print control)

Description		Selection	Program code	Default value
Print gross sales total (GROSS) on fixed total report.	a	Yes = 0 No = 1	<input type="checkbox"/> (a+b+c) D10	<input type="text" value="0"/> (a+b+c) D10
Print net sales total (NET) on fixed total report.	b	Yes = 0 No = 2		
Print cash in drawer (CAID) on fixed total report.	c	Yes = 0 No = 4		
Print charge in drawer (CHID) on fixed total report.		Yes = 0 No = 2	<input type="checkbox"/> D9	<input type="text" value="0"/> D9
Print check in drawer (CKID) on fixed total report.	a	Yes = 0 No = 1	<input type="checkbox"/> (a+b) D8	<input type="text" value="0"/> (a+b) D8
Print credit in drawer on (CRID(1) ~ (4)) on fixed total report.	b	Yes = 0 No = 4		
Must be "0"			<input type="text" value="0"/> D7	<input type="text" value="0"/> D7
Print RF mode total (RF) on fixed total report.		Yes = 0 No = 4	<input type="checkbox"/> D6	<input type="text" value="0"/> D6
Print the net number of customers (CUST) on fixed total report.	a	Yes = 0 No = 1	<input type="checkbox"/> (a+b) D5	<input type="text" value="2"/> (a+b) D5
Print average sales per customer (AVER) on fixed total report.	b	Yes = 0 No = 2		
Must be "0"			<input type="text" value="0"/> D4	<input type="text" value="0"/> D4
Print commission 1 total (C-1) on fixed total report.	a	Yes = 0 No = 1	<input type="checkbox"/> (a+b+c) D3	<input type="text" value="7"/> (a+b+c) D3
Print commission 2 total (C-2) on fixed total report.	b	Yes = 0 No = 2		
Print foreign currency cash in drawer (CECA1, CECA2) and check in drawer (CECK1, CECK2) on fixed total report.	c	Yes = 0 No = 4		
Print <MINUS>, <COUPON>, <%-> and mix & match operation net total (DC) on fixed total report.	a	Yes = 0 No = 1	<input type="checkbox"/> (a+b) D2	<input type="text" value="3"/> (a+b) D2
Print total number of <REFUND> operation (RF) on fixed total report.	b	Yes = 0 No = 2		
Print nontaxable totals (NON TAX) on fixed total report.	a	Yes = 0 No = 1	<input type="checkbox"/> (a+b+c) D1	<input type="text" value="3"/> (a+b+c) D1
Print rounded fractions (ROUND) on fixed total report.	b	Yes = 0 No = 2		
Print number of cancellation (CANCEL) on fixed total report.	c	Yes = 0 No = 4		

Advanced programmings and registrations

Example:

- On the fixed total report, not printing gross sales total (a = 1), not printing net sales total (b = 2), not printing cash in drawer. (c = 4): D10 = 7 (1 + 2 + 4).
- Not printing amount in drawer on fixed total report: D9 = 1.
- On fixed total report, not printing check amount in drawer (a = 1), not printing credit amount in drawer (b = 4): D8 = 5 (1 + 4).
- D7 must be always 0.
- Not printing refunded amount in RF mode on fixed total report: D6 = 4.
- Not printing total number of customers on fixed total report (a = 1), not printing average sales amount per customer (b = 2): D5 = 5 (1 + 4).
- D4 must be always 0.
- On fixed total report, not printing commission 1 amount (a = 1), not printing commission 2 amount (b = 2), not printing amount of foreign currency cash and check (c = 4): D3 = 7 (1 + 2 + 3).
- On fixed total report, not printing net total of <MINUS>, <COUPON>, <%-> etc. (a = 1), not printing <REFUND> and <VOID> amounts (b = 2): D2 = 3 (1 + 2).
- On fixed total report, not printing non-taxable amounts (a = 1), not printing rounded down amount (b = 2), not printing cancelled amount (c = 4): D1 = 7 (1 + 2 + 3).

Press **3** **0 8 2 2** **7 1 5 0 4 5 0 7 3 7**

Set code 10 (Print control of taxable amount)

Description	Selection	Program code	Default value
Print taxable amount 1 on receipt/journal.	a Yes = 0 No = 1	<input type="checkbox"/> (a+b+c) D10	<input type="text" value="0"/> (a+b+c) D10
Print taxable amount 2 on receipt/journal.	b Yes = 0 No = 2		
Print taxable amount 3 on receipt/journal.	c Yes = 0 No = 4		
Print taxable amount 4 on receipt/journal.	Yes = 0 No = 1	<input type="checkbox"/> D9	<input type="text" value="0"/> D9
Must be "00000000" (eight zeros)		<input type="text" value="0"/> to <input type="text" value="0"/> D8 to D1	<input type="text" value="0"/> to <input type="text" value="0"/> D8 to D1

Advanced programmings and registrations

Set code 15 (Printing methods of sales reports)

Description	Selection	Program code	Default value
Department zero skip (Departments of sales amount zero are not printed on sales reports.)	a Yes = 0 No = 1	<input type="checkbox"/> (a+b) D10	<input type="checkbox"/> 0 (a+b) D10
Clerk zero skip (Zero amounted clerks are not printed on sales reports.)	b Yes = 0 No = 2		
Transaction key zero skip (Transaction keys of sales amount zero are not printed on sales reports.)	a Yes = 0 No = 1	<input type="checkbox"/> (a+b+c) D9	<input type="checkbox"/> 0 (a+b+c) D9
PLU zero skip (Zero amounted PLUs are not printed on sales reports.)	b Yes = 0 No = 2		
Hourly sales report skip (Zero amounted time zones are not printed on sales reports.)	c Yes = 0 No = 4		
Group zero skip (Zero amounted groups are not printed on sales reports.)	Yes = 0 No = 1	<input type="checkbox"/> D8	<input type="checkbox"/> 0 D8
Must be "00"		<input type="checkbox"/> 0 <input type="checkbox"/> 0 D7 D6	<input type="checkbox"/> 0 <input type="checkbox"/> 0 D7 D6
Print PLU numbers on the PLU report.	No = 0 Yes = 4	<input type="checkbox"/> D5	<input type="checkbox"/> 0 D5
Print sales ratio on sales reports.	a No = 0 Yes = 1	<input type="checkbox"/> (a+b) D4	<input type="checkbox"/> 0 (a+b) D4
Issue double Z reports.	b No = 0 Yes = 2		
Must be "000"		<input type="checkbox"/> 0 <input type="checkbox"/> 0 <input type="checkbox"/> 0 D3 D2 D1	<input type="checkbox"/> 0 <input type="checkbox"/> 0 <input type="checkbox"/> 0 D3 D2 D1

Set code 16 (Printing methods of grand total)

Description	Selection	Program code	Default value
Print range of consecutive number on fixed total report.	No = 0 Yes = 1	<input type="checkbox"/> D7	<input type="checkbox"/> 0 D7
Must be "00111"		<input type="checkbox"/> 0 <input type="checkbox"/> 0 <input type="checkbox"/> 1 <input type="checkbox"/> 1 <input type="checkbox"/> 1 D6 D5 D4 D3 D2	<input type="checkbox"/> 0 <input type="checkbox"/> 0 <input type="checkbox"/> 1 <input type="checkbox"/> 1 <input type="checkbox"/> 1 D6 D5 D4 D3 D2
Print grand total on daily sales reset (Z) report.	Yes = 0 No = 1	<input type="checkbox"/> D1	<input type="checkbox"/> 0 D1

Advanced programmings and registrations

Set code 17 (Date/time printing on journals/receipts)

Description	Selection	Program code	Default value
Print date on journal.	a Yes = 0 No = 2	<input type="checkbox"/> (a+b) D4	<input type="checkbox"/> 0 (a+b) D4
Print consecutive number on receipt/journal.	b Yes = 0 No = 4		
Print time on receipt.	a Yes = 0 No = 1	<input type="checkbox"/> (a+b) D3	<input type="checkbox"/> 0 (a+b) D3
Print time on journal.	b Yes = 0 No = 2		
Must be "00"		<input type="checkbox"/> 0 <input type="checkbox"/> 0 D2 D1	<input type="checkbox"/> 0 <input type="checkbox"/> 0 D2 D1

Set code 19 (Double height character printing on receipts)

Description	Selection	Program code	Default value
Print receipt in double height characters	No = 0 Yes = 1	<input type="checkbox"/> D7	<input type="checkbox"/> 0 D7
Must be "000000" (six zeros)		<input type="checkbox"/> 0 <input type="checkbox"/> 0 <input type="checkbox"/> 0 <input type="checkbox"/> 0 <input type="checkbox"/> 0 <input type="checkbox"/> 0 D6 D5 D4 D3 D2 D1	<input type="checkbox"/> 0 <input type="checkbox"/> 0 <input type="checkbox"/> 0 <input type="checkbox"/> 0 <input type="checkbox"/> 0 <input type="checkbox"/> 0 D6 D5 D4 D3 D2 D1

Set code 21 (Printing methods of messages)

Description	Selection	Program code	Default value
Print graphic type logo. (If "No" is selected, character logo will be printed.)	No = 0 Yes = 2	<input type="checkbox"/> D10	<input type="checkbox"/> 2 D10
Must be "000"		<input type="checkbox"/> 0 <input type="checkbox"/> 0 <input type="checkbox"/> 0 D9 D8 D7	<input type="checkbox"/> 0 <input type="checkbox"/> 0 <input type="checkbox"/> 0 D9 D8 D7
Print commercial message on receipts in REG/RF mode.	a No = 0 Yes = 1	<input type="checkbox"/> (a+b) D6	<input type="checkbox"/> 0 (a+b) D6
Print bottom message on receipts in REG/RF mode.	b No = 0 Yes = 2		
Must be "0000"		<input type="checkbox"/> 0 <input type="checkbox"/> 0 <input type="checkbox"/> 0 <input type="checkbox"/> 0 D5 D4 D3 D2	<input type="checkbox"/> 0 <input type="checkbox"/> 0 <input type="checkbox"/> 0 <input type="checkbox"/> 0 D5 D4 D3 D2
Must be "0".		<input type="checkbox"/> 0 D1	<input type="checkbox"/> 0 D1

Advanced programmings and registrations

Set code 27 (Clerk operation selections)

Description	Selection	Program code	Default value
Allow clerk functions.	No = 0 Yes = 4	<input type="checkbox"/> D9	<input type="checkbox"/> 0 D9
Must be "00000000"		<input type="checkbox"/> 0 to <input type="checkbox"/> 0 D8 to D1	<input type="checkbox"/> 0 to <input type="checkbox"/> 0 D8 to D1

Set code 30 (Thermal printer control)

Description	Selection	Program code	Default value
Print preset receipt message and graphic.	a No = 0 Yes = 1	<input type="checkbox"/> (a+b) D5	<input type="checkbox"/> 0 (a+b) D5
Print preset receipt message and graphic:① at the bottom of the receipt, ② at the top of the receipt	b ① = 0 ② = 2		
Journal compressed print (print half height characters)	Yes = 0 No = 1	<input type="checkbox"/> D4	<input type="checkbox"/> 0 D4
Must be "000"		<input type="checkbox"/> 0 <input type="checkbox"/> 0 <input type="checkbox"/> 0 D3 D2 D1	<input type="checkbox"/> 0 <input type="checkbox"/> 0 <input type="checkbox"/> 0 D3 D2 D1

Set code 34 (Backlight control)

Description	Selection	Program code	Default value
Backlight	Functions = 0 Not functions = 1	<input type="checkbox"/> D4	<input type="checkbox"/> 0 D4
Must be "000"		<input type="checkbox"/> 0 <input type="checkbox"/> 0 <input type="checkbox"/> 0 D3 D2 D1	<input type="checkbox"/> 0 <input type="checkbox"/> 0 <input type="checkbox"/> 0 D3 D2 D1

Programming functions of departments and PLUs in a lump

There are two methods to set functions of departments or PLUs which are programming at once and programming individual functions.

Programming department functions in a lump

This method programs function of a department at one time.

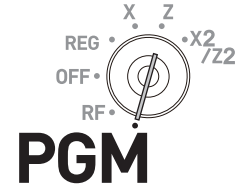

Step	Operation
<p>1 Turn the Mode switch to PGM position and select [System Setting] then press key.</p>
<p>2 Enter 3 and press key to set the register in the programming mode.</p>	
<p>3 You can skip this step if you program in departments 01 through 30. If you wish to program in departments 31 through 60, press key.</p>	
<p>4 Referring following table, input 12- digit program code.</p> [Program code (12 digits)]
<p>5 Press the department key you wish to program</p>	 For example, programming in dept. 26.
<p>6 Repeat steps 3 through 5 if you wish to program functions in another departments.</p>	
<p>7 Press key to complete the program.</p>	

Example:

Programming department 31 as;

- Normal item: D12 = 0.
- D11 through D8 must be 0000.
- US taxable status 1 (a = 1) and 2 (b = 2): D7 = 3 (1 + 2)
- Allowing zero unit price (a = 1), not allowing negative unit price (b = 0), hash item (c = 4): D6 = 5 (1 + 0 + 4).
- D5 must always be 0.
- Limiting minimum entry digit: 3 digits: D4 = 3.
- As this example is for setting functions in a department, D3 should be 0.
- Applying commission 1 (a = 1), not applying commission 2 (b = 0): D2 = 1 (1 + 0).
- D1 must always be 0.

Press

Useful features

Advanced programmings and registrations

Department and PLU lump set code

Description		Selection	Program code	Default value
Single item sales: Normal item = 0, Single item = 3		0 or 3	<input type="checkbox"/> D12	<input type="checkbox"/> D12
Must be "0000"		0000	<input type="checkbox"/> <input type="checkbox"/> <input type="checkbox"/> <input type="checkbox"/> D11 D10 D9 D8	<input type="checkbox"/> <input type="checkbox"/> <input type="checkbox"/> <input type="checkbox"/> D11 D10 D9 D8
Taxable status	Taxable status 1	a No = 0 Yes = 1	<input type="checkbox"/> (a+b+c) D7	<input type="checkbox"/> D7
	Taxable status 2	b No = 0 Yes = 2		
	Taxable status 3	c No = 0 Yes = 4		
	Taxable status for Canada	Non tax = 0, Taxable 1 = 1, Taxable 2 = 2, Taxable 3 = 3, Taxable 4 = 4, Taxable 1 & 2 = 5, Taxable 1 & 3 = 6, Taxable 1 & 4 = 7		
Enable zero unit price.	a	No = 0 Yes = 1	<input type="checkbox"/> (a+b+c) D6	<input type="checkbox"/> (a+b+c) D6
Enable negative price.	b	No = 0 Yes = 2		
Hash item	c	No = 0 Yes = 4		
Must be "0"		0	<input type="checkbox"/> D5	<input type="checkbox"/> D5
Low digit limitation (LDL) for manually entered unit price.		Number of digits	<input type="checkbox"/> D4	<input type="checkbox"/> D4
Open PLU (only for PLU)		No = 0 Yes = 4	<input type="checkbox"/> D3	<input type="checkbox"/> D3
Commission 1 (give commission on items)	a	No = 0 Yes = 1	<input type="checkbox"/> (a+b) D2	<input type="checkbox"/> (a+b) D2
Commission 2	b	No = 0 Yes = 2		
Must be "0"			<input type="checkbox"/> D1	<input type="checkbox"/> D1

Advanced programmings and registrations

Programming PLU functions in a lump

This method programs functions of a PLU at one time.

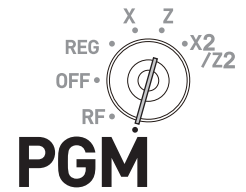

Step

- 1 Turn the Mode switch to PGM position and select [System Setting] then press key.
- 2 Enter **3** and press key to set the register in the programming mode.
- 3 Enter four-digit PLU number then press key.
- 4 Referring the table in the previous section, input 12- digit program code.
- 5 Press key.
- 6 Repeat steps 3 through 5 if you wish to program functions in another PLU.
- 7 Press key to complete the program.

Operation



For example, to program PLU number fourteen.









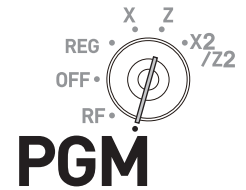









Programming functions of departments and PLUs individually

Programming functions of departments individually

This part explains programming methods of each function of departments individually.



Step	Operation
1 Turn the Mode switch to PGM position and select [System Setting] then press  key.	  
2 Enter 3 and press  key to set the register in the programming mode.	3 
3 Referring the following table, enter two-digit set code you wish to program followed by two 6s. The “66” is the identification code for individual programming of departments and PLUs. Then press  key.	  6 6  (set code)
4 You can skip this step if you program in departments 01 through 30. If you wish to program in departments 31 through 60, press  key.	
5 Referring the following table, enter program code and press the department key in which you wish to set.	1 2 3  3 This example is for linking dept. 03 to item group 123 assuming set code 11 has been entered in step 3 and  key is not pressed in step 4.
6 If you wish to set the same function in another department, press the corresponding dept. key.	 4 This example is for setting the same linking group in dept. 04.
7 Repeat steps 4 and 5 to set another function in another department.	
8 Press  key to complete the program.	

Advanced programmings and registrations

Set code table

Set code	Description		Selection	Program code
03	Taxable status	Always "0"	0	<input type="checkbox"/> 0 D2
		Taxable status 1	a No = 0 Yes = 1	<input type="checkbox"/> (a+b+c) D1
		Taxable status 2	b No = 0 Yes = 2	
	Taxable status 3	c No = 0 Yes = 4		
	Taxable status for Canada	Non tax = 00, Taxable 1 = 01, Taxable 2 = 02, Taxable 3 = 03, Taxable 4 = 04, Taxable 1 & 2 = 05, Taxable 1 & 3 = 06, Taxable 1 & 4 = 07	00 to 07	<input type="checkbox"/> <input type="checkbox"/> D2 D1
04	Open PLU (Only for PLU)		No = 0 Yes = 4	<input type="checkbox"/>
05	Allow unit price 0		a No = 0 Yes = 1	<input type="checkbox"/> (a+b+c)
	Allow negative unit price.		b No = 0 Yes = 2	
	Hash item		c No = 0 Yes = 4	
07	Minimum digit of manual input unit price		Number of minimum digit	<input type="checkbox"/>
09	Commission 1		a No = 0 Yes = 1	<input type="checkbox"/> (a+b)
	Commission 2		b No = 0 Yes = 2	
11	Linking group (000 to 999)		000 to 999	<input type="checkbox"/> <input type="checkbox"/> <input type="checkbox"/> D7 D6 D5
	Must be 0		0	<input type="checkbox"/> 0 D4
	Linking dept. (000 to 999) (Only for PLU)		000 to 999	<input type="checkbox"/> <input type="checkbox"/> <input type="checkbox"/> D3 D2 D1
15	Maximum amount of manual input unit price (up to 9999.99)			<input type="checkbox"/> <input type="checkbox"/> <input type="checkbox"/> <input type="checkbox"/> <input type="checkbox"/> <input type="checkbox"/> D6 D5 D4 D3 D2 D1
18	Single item control: Normal item = 0, Single item = 3		0 or 3	<input type="checkbox"/>

Example 1: To program dept. 01 as USA taxable 1 & 2

3 SUB TOTAL **0 3 6 6** SUB TOTAL **0 3** 1 SUB TOTAL

Example 2: To program dept. 02 to allow manual input unit price up to \$99.00.

3 SUB TOTAL **1 5 6 6** SUB TOTAL **9 9 0 0** 2 SUB TOTAL

Advanced programmings and registrations

Programming functions of PLUs individually

This part explains programming methods of each function of PLUs individually.

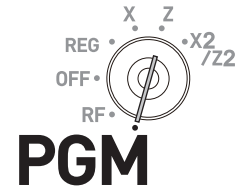

Step	Operation
<p>1 Turn the Mode switch to PGM position and select [System Setting] then press key.</p>
<p>2 Enter 3 and press key to set the register in the programming mode.</p>	3
<p>3 Referring the tables in the proceeding section, enter two-digit set code you wish to program followed by two 6s. The “66” is the identification code for individual programming of departments and PLUs. Then press key.</p>	6 6 (set code)
<p>4 Enter PLU number you wish to set and press key.</p>	0 0 0 5
<p>5 Referring the table in the preceding section, enter program code and press key.</p> (Program code)
<p>6 If you wish to set the same program code in the next PLU number, press key again.</p> <p>Perform step 5 if you wish to set another program code to the next PLU number.</p> <p>To program in another PLU number (not next PLU number), repeat steps 4 and 5.</p>	
<p>7 Press key to complete the settings.</p>	

Example 1: To set PLU 0001 as “Open PLU”.

Press **3** **0** **4** **6** **6** **0** **0** **0** **1** **4**

Example 2: To set PLU0012 to link item group 12 and dept. 04.

Press **3** **1** **1** **6** **6** **0** **0** **1** **2** **0** **1** **2** **0** **0** **0** **4**

Advanced programmings and registrations

Programming functions of transaction keys

This section explains how you can program functions in each transaction keys such as , or keys. For example, programming key to force entry of tendered amount.

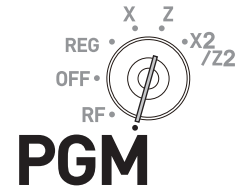

Step	Operation
1 Turn the Mode switch to PGM position and select [System Setting] then press <input type="button" value="CA/AMT/TEND"/> key.	<input type="button" value="↓"/> <input type="button" value="↓"/> <input type="button" value="CA/AMT/TEND"/>
2 Enter <input type="button" value="3"/> and press <input type="button" value="SUB TOTAL"/> key to set the register in the programming mode.	<input type="button" value="3"/> <input type="button" value="SUB TOTAL"/>
3 Referring the following tables, enter the program code then press corresponding transaction key.	<input type="text" value=""/> <input type="text" value=""/> <input type="button" value="−"/> (Program code) The above example is for programming minus key.
4 If you wish to program another transaction key, return to step 3.	
5 Press <input type="button" value="SUB TOTAL"/> key to complete the program.	<input type="button" value="SUB TOTAL"/>

Program code tables

NOTE Default value of all the program codes are "0".

Program code for , and keys.

Description	Selection	Program code
Prohibit partial payment.	No = 0 Yes = 1	<input type="text" value=""/> (a+b+c) D7
Prohibit tendered amount entry	No = 0 Yes = 2	
Force to enter tendered amount.	No = 0 Yes = 4	
Print breakdown of VAT. (Option for Single item or Currency exchange (including partial tendering foreign currency).)	No = 0 Yes = 1	<input type="text" value=""/> D6
Must be "0"	0	<input type="text" value=""/> D5
Maximum amount for subtotal and tendered amount. e.g.) \$9000, D4 = 9, D3 = 3	D4: Maximum value (0 ~ 9)	<input type="text" value=""/> <input type="text" value=""/>
	D3: Number of zeros (0 ~ 9)	D4 D3
Maximum amount of change due.	Maximum value (0 ~ 9)	<input type="text" value=""/> <input type="text" value=""/>
	Number of zeros (0 ~ 9)	D2 D1

Example 1: To set key as prohibiting partial payment (a = 1), not prohibiting tendered amount entry (b = 0), and forcing to enter tendered amount (c = 4): D7 = 6.

Press

Advanced programmings and registrations

Program code for RA and PO keys

Description	Selection	Program code
Maximum amount. e.g.) \$10,000; D4 = 1, D3 = 4.	Maximum value (0 ~ 9)	<input type="checkbox"/> <input type="checkbox"/> D4 D3
	Number of zeros (0 ~ 9)	
Must be "00"	00	<input type="checkbox"/> <input type="checkbox"/> D2 D1

Example: To set PO key not allowing to enter more than \$900.

Press PO

Program code for - key

Description		Selection	Program code
Taxable status	Always "0"	0	<input type="checkbox"/> <input type="checkbox"/> D8
	Taxable status 1	a No = 0 Yes = 1	<input type="checkbox"/> (a+b+c) D7
	Taxable status 2	b No = 0 Yes = 2	
	Taxable status 3	c No = 0 Yes = 4	
Taxable status for Canada	Non tax = 00, Taxable 1 = 01, Taxable 2 = 02, Taxable 3 = 03, Taxable 4 = 04, Taxable 1 & 2 = 05, Taxable 1 & 3 = 06, Taxable 1 & 4 = 07	00 to 07	<input type="checkbox"/> <input type="checkbox"/> D8 D7
Allow credit balance.		No = 0 Yes = 1	<input type="checkbox"/> D6
Must be "00"		00	<input type="checkbox"/> <input type="checkbox"/> D5 D4
Maximum digit of manual input unit price (Setting "9" programs NOT allowing manual entry.)		Number of digit	<input type="checkbox"/> D3
Give commission 1	a No = 0 Yes = 1	<input type="checkbox"/> (a+b+c) D2	
Give commission 2	b No = 0 Yes = 2		
Prepared status (Canadian tax)	c No = 0 Yes = 4		
Must be "0"		0	<input type="checkbox"/> <input type="checkbox"/> D1

Advanced programmings and registrations

Program code for %- key

Description		Selection	Program code
Taxable status	Always "0"	0	<input type="checkbox"/> 0 D8
	Taxable status 1	a No = 0 Yes = 1	<input type="checkbox"/> (a+b+c) D7
	Taxable status 2	b No = 0 Yes = 2	
	Taxable status 3	c No = 0 Yes = 4	
Taxable status for USA	Non tax = 00, Taxable 1 = 01, Taxable 2 = 02, Taxable 3 = 03, Taxable 4 = 04, Taxable 1 & 2 = 05, Taxable 1 & 3 = 06, Taxable 1 & 4 = 07	00 to 07	<input type="checkbox"/> <input type="checkbox"/> D8 D7
Prohibit manual rate entry.		No = 0 Yes = 2	<input type="checkbox"/> D6
Rounding: Round off = 0, Cut off = 1, Round up = 2		0, 1 or 2	<input type="checkbox"/> D5
Must be "00"		00	<input type="checkbox"/> <input type="checkbox"/> D4 D3
Give commission 1	a	No = 0 Yes = 1	<input type="checkbox"/> (a+b+c)D2
Give commission 2	b	No = 0 Yes = 2	
Must be "0"		0	<input type="checkbox"/> D1

Program code for #NS key

Description	Selection	Program code
Allow mode change or clerk change after <input type="checkbox"/> # <input type="checkbox"/> NS key operation as first transaction. (Only for non-add function)	Yes = 0 No = 1	<input type="checkbox"/> D7
Must be "000000"	000000	<input type="checkbox"/> <input type="checkbox"/> <input type="checkbox"/> <input type="checkbox"/> <input type="checkbox"/> <input type="checkbox"/> D6 D5 D4 D3 D2 D1

Program code for SUB TOTAL key

Description	Selection	Program code
Print when the key is pressed.	No = 0 Yes = 4	<input type="checkbox"/> D6
Always "00000"	00000	<input type="checkbox"/> <input type="checkbox"/> <input type="checkbox"/> <input type="checkbox"/> <input type="checkbox"/> D5 D4 D3 D2 D1

Advanced programmings and registrations

Program code for key

Description	Selection	Program code
Multiplication procedure ① Quantity × Amount, ② Amount × Quantity	① = 0 ② = 1	<input type="checkbox"/> D6
Roundings: Round off = 0, Cut off = 1, Round up = 2	0, 1, or 2	<input type="checkbox"/> D5
Must be "0000"	0000	<input type="checkbox"/> <input type="checkbox"/> <input type="checkbox"/> <input type="checkbox"/> D4 D3 D2 D1

Program code for and keys

Description	Selection	Program code
Taxable status (01 ~ 04) (Taxable 1 if "00" is set)	01 to 04	<input type="checkbox"/> <input type="checkbox"/> D8 D7
Must be "000000"	000000	<input type="checkbox"/> <input type="checkbox"/> <input type="checkbox"/> <input type="checkbox"/> <input type="checkbox"/> <input type="checkbox"/> D6 D5 D4 D3 D2 D1

Program code for key.

Description	Selection	Program code
Prohibit partial payment.	No = 0 Yes = 1	<input type="checkbox"/> (a+b+c) D7
Prohibit tendered amount entry	No = 0 Yes = 2	
Force to enter tendered amount.	No = 0 Yes = 4	
Print breakdown of VAT.	No = 0 Yes = 1	<input type="checkbox"/> D6
Must be "0"	0	<input type="checkbox"/> D5
Maximum amount for subtotal and tendered amount. e.g.) \$9000, D4 = 9, D3 = 3	D4: Maximum value (0 ~ 9)	<input type="checkbox"/> <input type="checkbox"/> D4 D3
	D3: Number of zeros (0 ~ 9)	
Must be "00"	00	<input type="checkbox"/> <input type="checkbox"/> D2 D1

Advanced programmings and registrations

Programming further clerk functions

This section explains how you can set further programming for clerks such as setting the register in training mode or setting commission rates given to clerks. In the training mode, the register operates normally but the results will not be stored in the memory. You can use this feature for getting to know the operations of the cash register for yourself or for newly hired clerks.

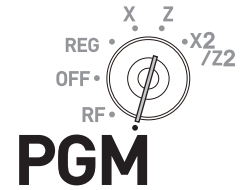

Step	Operation
1 Turn the Mode switch to PGM position and select [System Setting] then press key.
2 Enter 3 and press key to set the register in the programming mode.	3
3 Enter 2 -digit clerk number followed by 07. The “07” is the identification code for further program of clerks. Then press o key. The example on the right is for programming to clerk number 10.	1 0 0 7 (Clerk no.)
4 Referring the following tables, input the set code you wish to program and press key. The example on the right is for setting a commission rate.	6 8 (set code)
5 Enter the program code and press key. The example on the right is for setting 8.5% to commission rate 1 and 5% to commission 2.	0 8 5 0 0 5 0 0 (program code)
6 If you wish to set the same program to the next clerk number, perform the step 5 again. When you set to another clerk (not next clerk number), repeat steps 3 through 5.	
5 Press key to complete the settings.	

Set code 67 (Training mode)

Description	Selection	Program code
Training mode	No = 0 Yes = 1	<input type="checkbox"/> D6
Must be “00000”		0 0 0 0 0 D5 D4 D3 D2 D1

Example 1: To set the clerk number 15 as a clerk being trained.

Press **3** **1 5 0 7** **1 0 0 0 0 0 0**

Set code 68 (Commission rates)

Description	Selection	Program code
Commission rate 1 (integer)	00 to 99	<input type="checkbox"/> <input type="checkbox"/> D8 D7
Commission rate 1 (decimal)	00 to 99	<input type="checkbox"/> <input type="checkbox"/> D6 D5
Commission rate 2 (integer)	00 to 99	<input type="checkbox"/> <input type="checkbox"/> D4 D3
Commission rate 2 (decimal)	00 to 99	<input type="checkbox"/> <input type="checkbox"/> D2 D1

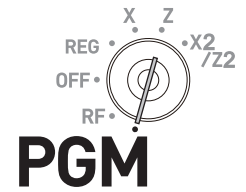

Printing programmed data

After programs have been set, you can print the programmed data.



To print programmed unit price or percentage (other than PLU)

Step

- 1 Turn the Mode switch to PGM position and select [System Setting] then press  key.
- 2 Enter **1** and press  key.
- 3 Press  key again. The printer starts to print preset data.

Printout





P01.....		1
CASH	@0.00	
-	@1.00	2
%-	10%	
<hr/>		
DEPT001	0001-05	3
	@1.00	4
DEPT002	0002-05	
	@2.00	

- 1: Program read symbol
- 2: Transaction key unit price or rate
- 3: Department descriptor/rec-#/05
- 4: Unit price

Advanced programmings and registrations

To print programmed characters (except PLUs)

Step

- 1 Turn the Mode switch to PGM position and select [System Setting] then press  key.
- 2 Enter  and press  key.
- 3 Press  key again. The printer starts to print preset data.

Printout



P02.....		1
GROSS	0001-01	
NET	0002-01	
CAID	0003-01	2
	0004-01	
	0005-01	
CASH	0001-02	
CHECK	0002-02	3
	0003-02	
	0004-02	
DEPT001	0001-05	
DEPT002	0002-05	4
	0003-05	
	0004-05	
GROUP01	0001-06	
GROUP02	0002-06	5
GROUP03	0003-06	
	0004-06	
C01	0001-07	
C02	0002-07	6
	0003-07	
	0004-07	
GT	0001-20	7
. @No/ ** /		
NoCT @LB *QT	0002-23	8
Y- CUSV	0003-23	
	0001-24	
FIX		
TRANS	0002-24	9
	0003-24	
	0004-24	
DAILY X	0001-29	10
PERIODIC 1X	0002-29	
PERIODIC 2X	0003-29	
	0004-29	
0001-32		
YOUR RECEIPT		11
0002-32		
THANK YOU		
0001-39		
CHARACTER RECALL*****		12

- 1: Program read symbol
- 2: Fix total character
- 3: Transaction key character
- 4: Department character
- 5: Group character
- 6: Clerk character
- 7: GT character
- 8: Special character
- 9: Report header character
- 10: Batch X/Z character
- 11: Receipt message
- 12: Text recall character

Advanced programmings and registrations

To print general programming (except PLUs)

Step

- 1 Turn the Mode switch to PGM position and select [System Setting] then press  key.
- 2 Enter **3** and press  key.
- 3 Press  key again. The printer starts to print preset data.

Printout

P03.....		1
CASH	0001-02	
	00000000000000	2
CHECK	0002-02	3
	00000000000000	4
FD	0003-02	
	00000000000000	
DEPT001	0001-05	5
	00000000000000	6
11-66	00000000	7
15-66	@1.23	8
	0002-05	
C01	0001-07	9
	0000010001	10
67	0000000000	11
68	00000000	12
	0001-09	
	00:00 -> 01:00	
	0002-09	13
	01:00 -> 02:00	
	02:00 -> 03:00	
0001-22	2200000000	
0002-22	0000000000	14
0003-22	0000000000	
0001-28		
0002-28		
0001-25		
TX1	10.25%	15
TX1	0000	
TX1	5003	
DAILY X	0001-29	16
00	11-12-17-15-00	
	00-00-00-00-00	
PERIODIC	1X 0002-29	

- 1: Program read symbol
- 2: Transaction key program
- 3: Key character/rec-#/file-#
- 4: Key program
- 5: Department program/Key character/rec-#/file-#
- 6: Key program
- 7: Address code 11 program
- 8: Address code 15 program
- 9: Clerk program/Clerk name/rec-#/file-#
- 10: Check #/secret-#
- 11: Compulsory
- 12: Commission rate
- 13: Time range program
- 14: General control program
- 15: Tax table
- 16: Batch X/Z program

Printout

0001-30 NET	0001-01 0020-01	17
0001-38 REG1	000001 204-000	18
1	001-000	19
2	002-000	
DEPT001	026-051	
CASH	013-001	
0001-62	000000 00000000000000 0000000000	20
MC#01	0001-91 00000000	
0001-98	0000000000000000	21
0002-98	0000000000000000	

- 17: Clerk detail link program
- 18: Arrangement program/Rec-#/file-#/arrange no.
- 19: Key descriptor/rec-#/file-#
- 20: Scheduler program
- 21: I/O parameter table

To print preset unit price of PLU

Step

- 1 Turn the Mode switch to PGM position and select [System Setting] then press key.
- 2 Enter **6** and press key to set the register in the programming mode.
- 3 Enter **1 0 4** and press key.
- 4 Enter starting PLU number and press key. For example, if you wish to print from PLU number 0001, input **0 0 0 1** .
- 5 Enter the last PLU number and press key. For example, if you wish to print up to PLU number 0884, input **0 8 8 4** .

Printout





P01.....	1
#0001 - #0884	2
PLU0001 0001-04	3
@1.00	4
PLU0002 0002-04	
@2.00	

- 1: Program read symbol
- 2: Range of PLU No.
- 3: PLU name/rec-#/04
- 4: Unit price

Advanced programmings and registrations

To print preset characters of PLU

Step

- 1 Turn the Mode switch to PGM position and select [System Setting] then press  key.
- 2 Enter **6** and press  key to set the register in the programming mode.
- 3 Enter **2 0 4** and press  key.
- 4 Enter starting PLU number and press  key.
- 5 Enter the last PLU number and press  key.

Printout





```

P02..... 1
      #0001 - #0010 2
PLU0001      0001-04 3
PLU0002      0002-04
PLU0003      0003-04
    
```

- 1: Program 2 mode symbol
- 2: Range of PLU No.
- 3: PLU character

To print PLU programmings

Step

- 1 Turn the Mode switch to PGM position and select [System Setting] then press  key.
- 2 Enter **6** and press  key to set the register in the programming mode.
- 3 Enter **3 0 4** and press  key.
- 4 Enter starting PLU number and press  key.
- 5 Enter the last PLU number and press  key.

Printout

```

P03..... 1
      #0001 - #0010 2
PLU0001      0001-04 3
                0000000000000000 4
11-66                000000 5
13-66      <- 0001-28 6
14-66                0
15-66                @1234.56 7
PLU0003      0002-04
    
```

- 1: Program 3 mode symbol
- 2: Range of PLU No.
- 3: PLU name/rec-#/file-#
- 4: Address code 01 ~ 10, 18 program
- 5: Address code 11 program
- 6: Address code 13 program
- 7: Address code 15 program

Advanced programmings and registrations

Printing various sales reports

You can print categorized sales reports such as PLU sales report, item group sales report, hourly sales report etc.

NOTE

- Please do not perform the reset (Z) report during the business hour as it clears stored sales data from the memory.
- Please see page E-47 for printout sample of a daily report.

Printing various sales reports

The followings are the example operation for printing an electronic journal of February 28, 2013.

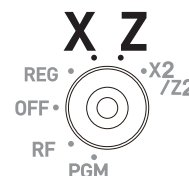

Step

1 Turn the Mode switch to X or Z position. The display shows the top menu of sales reports.

2 Using or keys select the report you wish to obtain. The example on the right is for selecting electronic journal. As it is the lowest column, [EJ] is hidden from the default top menu. Select it by keep pressing key.

3 Press key. The display shows the next screen asking date or consecutive number. Select [Date] and press key.

4 Input year, month, and day from ten key pad. The journal of assigned date will be printed if you press key.

Display

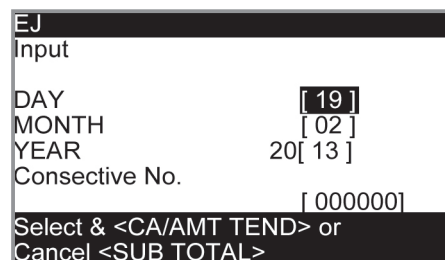
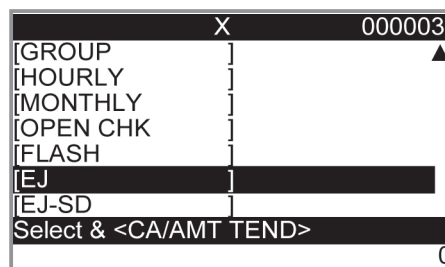
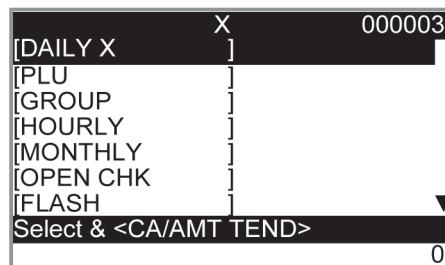

Useful features

Advanced programmings and registrations

■ PLU sales report

X	PLU		0000014	1
				2
	PLU0001	17		3
	0.53%	\$17.00		4
	#0001			5
	PLU0100	42		
	1.03%	\$69.00		
	#0100			

	TL	188.61		6
		\$516.10		7

- 1 Read symbol/report title
- 2 Report code
- 3 PLU name/Quantity
- 4 Sales ratio/PLU amount
- 5 PLU code
- 6 Total Quantity
- 7 Total amount

■ Item group sales report

X	GROUP		0000016	1
				2
	GROUP01	203.25		3
	33.87%	\$1,108.54		4
	GROUP02	183		
	40.58%	\$1,327.80		
	GROUP03	12		
	0.40%	\$13.25		
	GROUP99	13		
	0.54%	\$17.80		

	TL	862		5
		\$3,272.00		6

- 1 Read symbol/report title
- 2 Report code
- 3 Group No./Quantity
- 4 Sales ratio/group amount
- 5 Total quantity of group
- 6 Group total amount

■ Hourly sales report

X	HOURLY		0000019	1
				2
	00:00->01:00			3
	CT	1		4
	GROSS	\$1.10		5
	NET	No 1		6
	1.90%	\$1.20		7

	23:00->00:00			
	CT	1		
	GROSS	\$3.45		
	NET	No 1		
	3.90%	\$3.59		

	TL	CT 280		8
	GROSS	\$1,937.61		9
	NET	No 25		10
		\$2,096.80		11

- 1 Read symbol/report title
- 2 Report code
- 3 Time zone
- 4 No. of customers
- 5 Gross sales amount
- 6 No. of receipts
- 7 Sales ratio/net sales amount
- 8 Total No. of customers
- 9 Gross total amount
- 10 Total No. of receipt
- 11 Net total amount

Advanced programmings and registrations

■ Monthly sales report

X	MONTHLY		1
		0000020	2
	1.....		3
GROSS		1236.76	4
		\$12,202.57	5
NET	No	214	6
		\$12,202.57	7
	31.....		
GROSS		2132	
		\$14,187.57	
NET	No	205	
		\$13,398.76	

TL			8
GROSS		9746.63	9
		\$161,022.49	10
		\$16.52	11
NET	No	2351	12
		\$161,022.49	13
		\$68.49	14

- 1 Read symbol/report title
- 2 Report code
- 3 Month
- 4 Gross symbol/Quantity
- 5 Gross sales amount
- 6 Net symbol/No. of customers
- 7 Net sales amount
- 8 Total symbol
- 9 Gross symbol/Quantity
- 10 Gross sales amount
- 11 Daily gross sales average
- 12 Net symbol/No. of customers
- 13 Net sales amount
- 14 Daily net sales average

■ Flash report

X	FLASH		1
		0000071	2
DECLA		\$6,919.04	3
		\$0.00	4
GROSS		111.15	5
		\$7,054.14	
NET	No	120	6
		\$7,263.20	
CAID		\$6,919.04	7

- 1 Read report symbol/report title
- 2 Report code
- 3 Declared amount
- 4 Difference
- 5 Gross total
- 6 Net total
- 7 Cash in drawer

About “Declared money” and “Cash in drawer”

If you programmed the register to force entry of total amount in drawer, you need to count the money in the drawer and input the amount (money declaration) before read (X) or reset (Z) report printing. On the other hand, “Cash in drawer” is the total money in the drawer calculated by the register so that you can compare the actual amount and the calculated amount.

To program money declaration, please see page E-67.

Advanced programmings and registrations

■ Electronic journal

X	E-JOURNAL		1
		0000058	2
REG	06-20-2013	11:58	
C01	0001	000123	
1	DEPT001	T1	\$1.00
1	DEPT002	T1	\$2.00
5	DEPT003		\$5.00
		7 No	3
TA1			
TX1		\$0.15	
TX1		\$0.10	
TL		\$8.10	
CASH		\$10.00	
CG		\$1.90	
REG	06-20-2013	11:59	
C01	0001	000124	

- 1 Report header/title
- 2 Report code
- 3 Journal image

About electronic journal

Instead of printing days' sales journal, the register stores daily sales report in the memory and you can obtain the report by assigning day or consecutive number.

To print individual department and PLUs

Instead of printing sales reports in a lump, you can obtain reports of specific departments or PLUs.

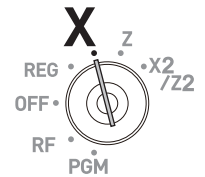

Step

- 1 Turn the Mode switch to X position.
- 2 Just press department keys or enter PLU numbers.
For example, for Dept.033.
 for PLUs 1 and 89.
- 3 Press key to exit from individual report printing.

Printout

X	INDIVIDUAL		1
DEPT033		38	2
	8.13%	\$257.53	3
PLU0001		17	4
	0.53%	\$17.00	5
#0001			6
TL		88.61	7
		\$516.10	8

- 1: Read symbol/report title
- 2: Department Name/No. of items
- 3: Sales ratio/amount
- 4: PLU Name/No. of items
- 5: Sales ratio/PLU amount
- 6: PLU code
- 7: Total No. of items
- 8: Total amount

Periodic sales report

Apart from daily report, you can obtain periodic sales report. The register prints total sales data from the last periodic report. Namely, if you do this operation monthly, you can obtain monthly sales reports. The cash register allows you to obtain two kinds of periodic reports so that not only monthly reports, you can also get weekly reports.

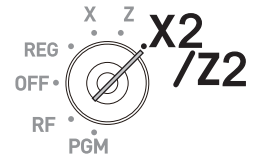

Step

1 Turn the Mode switch to X2/Z2 position. The display shows report selection screen.

2 Select a report using or keys. Z1 and Z2 clear the accumulated data while X1 and X2 store the sales data remained.

3 Press key. The printer prints out the periodic report.

Display

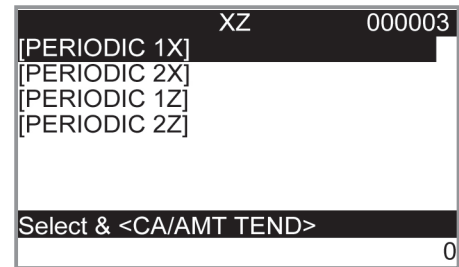

Advanced programmings and registrations

----- ZZ1 PERIODIC 1Z -----			1
ZZ1 DEPT		0001	2
		0001115	3
DEPT001		38	4
8.13%		\$257.53	5
DEPT002		18	
		\$1,382.26	
----- TL		88.61	6
		\$1,916.10	7
----- ZZ1 FIX		0001	8
		0001111	9
GROSS		981.25	10
		\$6,574.40	
NET	No	111	11
		\$7,057.14	
CAID		\$6,919.04	12
CHID		\$139.04	13
CKID		\$859.85	14
CRID(1)		\$709.85	15
CRID(2)		\$0.00	16
CRID(3)		\$0.00	17
CRID(4)		\$0.00	18
----- RF	No	3	19
		\$10.22	
CUST	CT	111	20
AVRG		\$63.57	21
DC		\$1.22	22
REF		\$2.42	23
ROUND		\$0.00	24
CANCEL	No	2	25
		\$12.97	
----- TA1		\$2,369.69	26
TX1		\$128.86	27
TA2		\$2,172.96	28
TX2		\$217.33	29

- 1 Report title
- 2 Department report title/reset counter
- 3 Report code
- 4 Department Name/No. of items *1
- 5 Sales ratio/amount *1
- 6 Total No. of items
- 7 Total amount
- 8 Fixed total report title/reset counter
- 9 Report code
- 10 Gross total *2
- 11 Net total *2
- 12 Cash in drawer *2
- 13 Charge in drawer *2
- 14 Check in drawer *2
- 15 Credit in drawer 1 *2
- 16 Credit in drawer 2 *2
- 17 Credit in drawer 3 *2
- 18 Credit in drawer 4 *2
- 19 Refund mode *2
- 20 Customer number *2
- 21 Average sales per customer *2
- 22 Discount total *2
- 23 Refund key *2
- 24 Rounding total *2
- 25 Cancellation *2
- 26 Taxable 1 amount *2
- 27 Tax 1 amount *2
- 28 Taxable 2 amount *2
- 29 Tax 2 amount *2

Advanced programmings and registrations

ZZ1	TRANS		0001	1
			0001112	2
CASH	No	362		3
		\$1,638.04		
CHARGE	No	56		
		\$1,174.85		
RC	No	4		
		\$810.00		
PD		5		
		\$5.00		
CORR	No	14		
		\$39.55		
RCT	No	3		
NS	No	5		

ZZ1	CASHIER		0001	4
			0001117	5
C01	1		6
NET	No	111		
		\$1,845.35		7
C02	1		8

- 1 Function key report title/reset counter
- 2 Report code
- 3 Function key count/amount ^{*1}
- 4 Clerk report title/reset counter
- 5 Report code
- 6 Clerk name
- 7 Net total
- 8 Clerk name

- ¹Zero totalled departments/functions (the amount and item numbers are both zero) are not printed.
- ²These items can be skipped by programming.

Advanced programmings and registrations

Using an SD card

You can store sales data or program data to an SD card or you can restore the data from SD card to your cash register.

The following table explains what you can do with an SD card.

[Backup→SD]	Stores sales data and program data of register to SD card.
[Restore←SD]	Restores sales data and program data from SD card to register.
[Program→SD]	Stores program data to SD card.
[Program←SD]	Restores program data from SD card to register.
[Backup→Flash]	Stores program data into the register's built-in flash memory (for a case of power failure with flat batteries).
[SD Format]	Formats an SD for the first usage.

The following sections explain the operation examples of the features using an SD card.

To format an SD card

When you use a new SD card, you must format the SD card first.

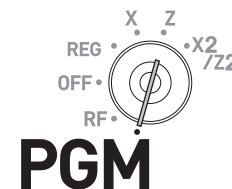

NOTE All the data stored in the SD card will be cleared if you execute formatting.

Step

Display

- 1 Insert an SD card into the SD card slot.
- 2 Turn the Mode switch to PGM position and select [SDcard Setting].
- 3 Press  key.
Select [SD Format] on the SD card setting screen.

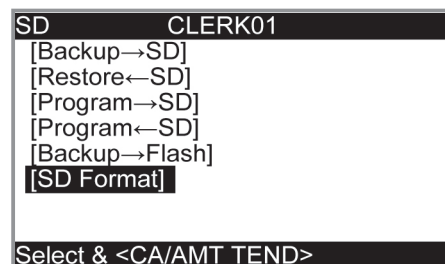
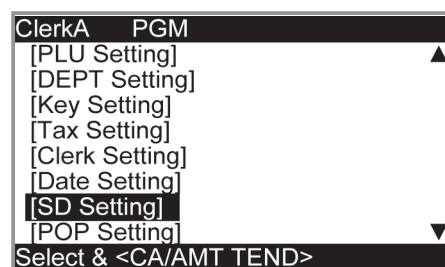

Advanced programmings and registrations

Step

- 4** Select [YES] and press  key.
The register starts to format the SD card.

- 5** Now the SD card is formatted and you can use it for storing cash register data in it.

Display

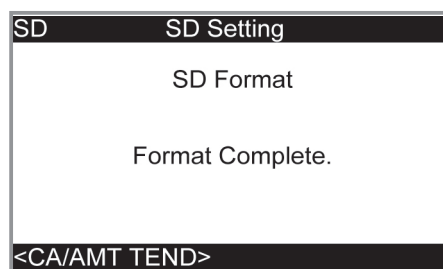
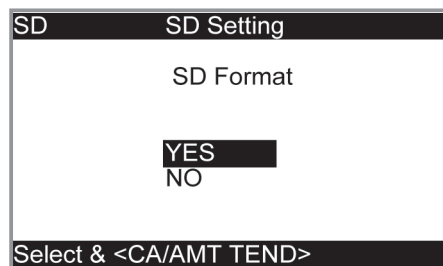

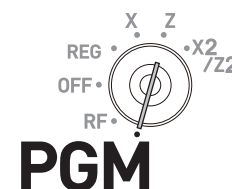

To store program data in an SD card

The following operation explains how you can back up all the program data in an SD card.



Useful features

Step

- 1** Insert an SD card into the SD card slot.
- 2** Turn the Mode switch to PGM position and select [SDcard Setting]. Then press  key.
- 3** Select [Program→SD] and press  key.

Display

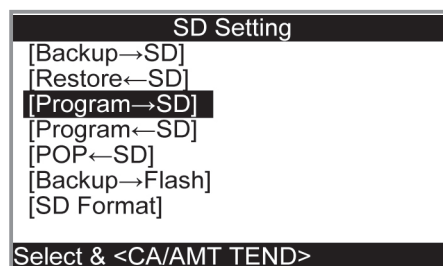
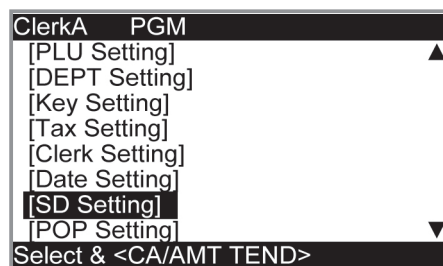

Advanced programmings and registrations

Step

4 Select [YES] and press  key.

5 After for a while, the display indicates “Backup complete”.

Display

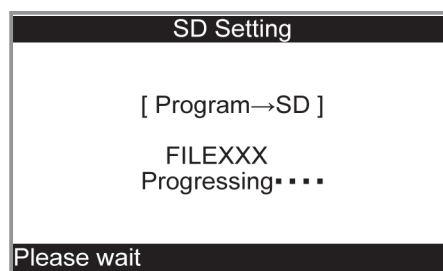
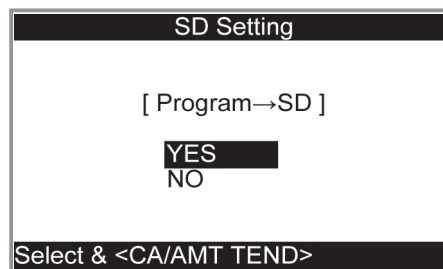

Advanced programmings and registrations

Before you consider it as a problem

Error code table

Error code	Message	Meaning	Action
E001	Wrong mode	Mode switch position changed before finalization.	Return the mode switch to its original setting and finalize the operation.
E003	Wrong operator	The signed on clerk differs from the clerk performed the tracking check registration.	Input correct check number or assign the proper clerk number.
E004	Error INIT/FC	Initialization or unit lock clear operation in progress.	Complete operation.
E008	Please sign on	Registration without entering a clerk number.	Enter a clerk number.
E010	Close the drawer	The drawer is left open longer than the program time (drawer open alarm).	Close the drawer.
E011	Close the drawer	Attempt to register while the cash drawer is open.	Close the drawer.
E016	Change back to REG mode	Two consecutive transactions attempted in the refund mode.	Switch to another mode and then back to the RF mode for the next transaction.
E017	Enter CHK/TBL number	Attempt made to register an item without inputting a check number.	Input a check number.
E018	Enter Table number	Attempt made to register an item without inputting a table number.	Input a table number.
E019	Enter number of customers	Finalize operation attempted without entering the number of customer.	Enter the number of customer.
E021	No DEPT Link	No department linked PLU is registered.	Correct the program.
E026	Enter condiment/preparation PLU	No condiment/preparation PLU is registered.	Register condiment/preparation PLU.
E029	In the tender operation	Item registration is prohibited, while partial tender.	Finalize the transaction.
E031	Press ST key	Finalization of a transaction attempted without confirming the subtotal.	Press  key.
E033	Enter tendered amount	Finalize operation attempted without entering amount tender.	Enter the amount tendered.
E035	Change amount exceeds limit	Change amount exceeds preset limit.	Input amount tendered again.
E036	Remove money from the drawer	Contents of the drawer exceed programmed limit.	Perform payout operation.
E037	Digit or amount limitation over	High amount lock out/low digit lock out error	Enter correct amount.
E038	Perform money declaration	Read/reset operation without declaring cash in drawer.	Perform money declaration.
E040	Issue guest receipt	Attempt to register a new transaction without issuing a guest receipt.	Issue a guest receipt.
E046	REG buffer full	Registration buffer full.	Finalize the transaction.
E049	CHECK memory full	Check tracking index memory full.	Finalize and close the check number currently used.

Advanced programmings and registrations

Error code	Message	Meaning	Action
E050	DETAIL memory full	Check tracking detail memory full.	Finalize and close the check number currently used.
E051	CHK/TBL No. is occupied	Attempt to made use <New Check> to open a new check using a number that is already used for an existing check in check tracking memory.	Finalize and close the check that is currently under the number that you want to use or use a different check number.
E053	CHK/TBL No. is not opened	Attempt made to use <Old Check> reopen a new check using a number that is not used for an existing check in check tracking memory.	Use the correct check number (if you want to reopen a check that already exists in check tracking memory) or use <New Check> to open a new check.
E075	Negative balance cannot be finalized	Attempt to finalize a transaction when balance is less than or equal to zero.	Register item(s) until the balance becomes positive amount.
E101	PLU maintenance file full. Press <#2> to exit	Scanning PLU direct maintenance/ batch maintenance file becomes full.	Terminate the maintenance.
E103	PLU Code is not exist. Input the PLU Code	PLU code is not existed in the file.	Enter proper PLU code.
E105	PLU file full	Scanning PLU file full	Modify the designated item.
E106	Item exists in the PLU FILE	The designated item has already existed in the scanning PLU file.	
E112	Close the journal platen arm	The journal platen arm is opened.	Close the journal platen arm.
E114	Close the receipt platen arm	The receipt platen arm is opened.	Close the receipt platen arm.
E139	Negative balance is not allowed	Attempt to register <-> or <CPN> when the balance becomes negative.	Enter proper minus/coupon amount.
E146	Arrangement file full	Arrangement file is full.	Set the arrangement properly.
E200	Insert SD	SD is set.	Set SD.
E201	Illegal Format	Illegally formatted SD	Format the SD.
E202	File not found	The designated file is not found in the SD.	Enter proper file name.
E205	File already exist.	Can not write, because designated file has already been in the SD.	Check the operation and retry.

When “EJ FULL” sign appears on the display

When the register shows this sign, issue electronic journal read report (if necessary) and reset the memory immediately.

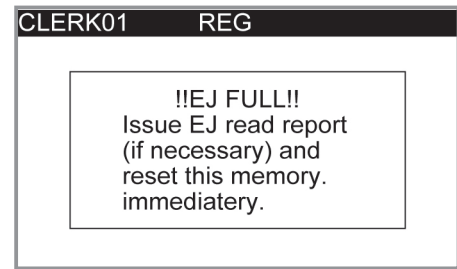



In case of power failure

If the power supply to the cash register is cut by a power failure or any other reason, simply wait for power to be restored. The details of any ongoing transaction as well as all sales data in memory are protected by the memory backup batteries. (This is the reason to install the batteries.)

- Power failure during a registration
The subtotal for items registered up to the power failure is retained in memory. You will be able to continue with the registration when power is restored.
- Power failure during printing a read / reset report
The data already printed before the power failure is retained in memory. You will be able to issue a report when power is restored.
- Power failure during printing of a receipt / journal
Printing will resume after power is restored. A line that was being printed when the power failure occurred is printed in full.
- Other
The power failure symbol is printed and any item that was being printed when the power failure occurred is reprinted in full.

In case the register is locked up

If you make a mistake in operation, the cash register may lock up to avoid damage to programs and preset data. Should it happens, you can use the following procedure to clear the lock up without losing any data.

- 1** Power off the register.
- 2** Insert the PGM key in the mode switch.
- 3** Press down , and turn the mode switch to PGM mode.
- 4** The display shows 0.00, then release .
- 5** Press,  then issue a receipt.

Advanced programmings and registrations

About the low battery indicator

If this indicator appears when you switch the cash register on, it can mean one of three things:

- No memory backup batteries are loaded in the cash register.
- The power of the batteries loaded in the unit is below a certain level.
- The batteries loaded in the unit are dead.

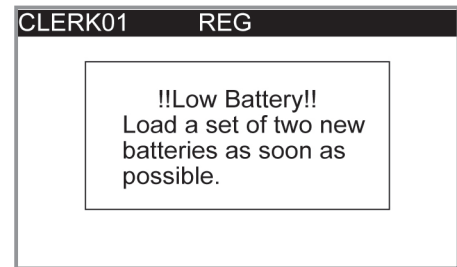

Important !

Whenever the low battery indicator appears on the display, load a set of two new batteries as soon as possible. If there is a power failure or you unplug the cash register when this indicator appears, you will lose all of your sales data and settings.

Be sure to keep the power cord of the cash register plugged in whenever you replace the batteries.

Category	No. of totalizers	Contents				Periodic totalizer
		Amount (10 digits)	No. of items (4 digits)	Count (4 digit)	No. of items (4 digits)	
Department	200	○ *1	○ *3			○
PLU	7000	○ *1	○ *3			
Hourly sales	24	○ *1		○ *4	○ *5	
Monthly sales	31	○ *1			○ *5	
Clerk	50	○ *1			○ *5	
Transaction key & fix total	--	○ *1 or ○ *3 or ○ *4 or ○ *5				○
Non resettable grand sales total	1	○ *2				
Reset counter	8			○ *4		○
Comsecutive No.	1				○ *5	

* 1 -9,999,999.99 ~ 99,999,999.99

* 2 -9,999,999,999,999.99 ~ 99,999,999,999,999.99

* 3 -99,999.999 ~ 999,999.999

* 4 1 ~ 9999

* 5 1 ~ 999999

Specifications and design are subject to change without notice.

Advanced programmings and registrations

Specifications

Entry	10-key system, buffer memory 8 keys (2-key roll over)
Department	Full key system
Main display	26 characters x 10 lines, Dept. name, PLU name, Total, Transaction names, Change
Customer display	20 characters x 1 line. Amount 10 digits (zero suppression)
Printer	
Receipt	Thermal alpha-numeric system 24 digits, receipt on/off key
	Store name or slogan is printed automatically
Journal	Thermal alpha-numeric system 24 digits
	Automatic take up roll winding
Paper roll	58 (W) × 80 (D) mm
Paper thickness	0.06 to 0.08 mm
Paper feed	Receipt and Journal
Print speed	About 14 l/s
Listing capacity	
Amount	9999999999
Quantity	9999.999
Tendered amount	9999999999
Percent	99.99
Tax rate	9999.9999
Numbers	9999999999999999
Chronological data	
Date print	Automatic date printout on receipt and journal, automatic calendar
Time print	Automatic time printout on receipt and journal, 24-hour system/12-hour system
Alarm	Key catch tone, error alarm
Memory protection battery	The effective service life of memory protection batteries (two new size AA manganese batteries) is approximately one year from installation into the machine.
Power supply/power consumption	See the rating plate.
Operation temperature	32°F to 104°F (0°C to 40°C)
Humidity	10 to 90%
Dimensions	220 mm (H) × 400 mm (W) × 450 mm (D) (8.6" (H) × 15.7" (W) × 17.7" (D))
Weight	10 kg (22 lbs.)

